



**WAECO**  
mobile solutions

# Installation & Operating Manual

**Adler-Barbour**  
It's a perfect mate!

› For **ADLER/BARBOUR SERIES**  
ColdMachine™  
SuperColdMachine™

# IMPORTANT NOTICE

Before you proceed, please read this manual from cover to cover.  
Failure to following instructions may void your warranty.

<b>Introduction</b> .....	3	<b>Operation of System</b> .....	24
Terminology .....	3	Start-Up .....	24
Unpacking Equipment .....	4	AC/DC Operation .....	24
Tools & Equipment Needed for Installation .....	4	Maintenance .....	24
		Defrosting .....	24
<b>Planning the Condensing Unit Installation</b> .....	4	Battery Care .....	24
Ventilation Requirements .....	4	Winter Operation .....	25
Duct Kits and Power Duct Kits .....	5		
Location Considerations .....	5	<b>Programming Digital Control</b> .....	25
		To Program Set Point .....	25
<b>Mounting the Condensing Unit</b> .....	6	To Program Differential .....	25
<b>Planning the Evaporator Installation</b> .....	6	<b>Electronic Module Protection System</b> .....	26
Evaporator Location Choices - Vertical Applications .....	6		
Optional Box Modifications & Combinations .....	7-8	<b>Operational Errors Indicated by LED on Condensing Unit</b> .....	26
Horizontal Applications .....	8		
		<b>Troubleshooting Guide</b> .....	27-29
<b>Mounting the Evaporator</b> .....	9		
Refrigerant Couplings .....	10-12	<b>Procedure for Removing Compressor Unit</b> .....	30
Installing the Analog Thermostat .....	13		
Installing the Digital Thermostat .....	14	<b>Procedure for Removing Evaporator &amp; Tubeset</b> .....	30
Mounting the PowerPlate .....	15		
		<b>Procedure for Removing PowerPlate &amp; Tube Set</b> .....	30
<b>Electrical Considerations</b> .....	16		
		<b>Warranty</b> .....	31
<b>Water Cooled Optional Package/Installation</b> .....	17		
Battery Recommendations .....	18	<b>Return Policy</b> .....	31
Wiring the System .....	18		
Voltage Drops .....	19		
Making the Power Connections .....	19		
Wire Size and Wire Size Table .....	19		
Wiring Diagrams .....	20-23		

## ***This manual covers:***

All air-cooled ColdMachine™ products and all air/  
water-cooled SuperColdMachine™ products with:

- Standard aluminum “bin” shaped evaporators
- Custom formed “flat”, “L”, “U” shaped evaporators
- PowerPlate stainless steel holdover evaporators
- Analog type thermostatic controls (standard)
- Digital type thermostatic controls (optional)



ColdMachine™

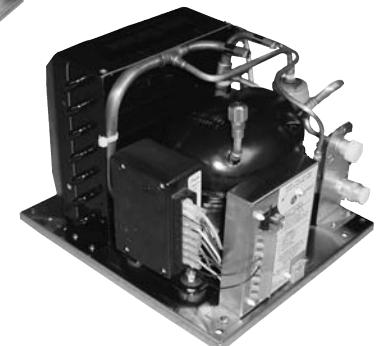

SuperColdMachine™

# INTRODUCTION

Thank you for purchasing your new ADLER/BARBOUR marine refrigeration system. This manual will explain how to install the system on your boat—in just a few hours—with ordinary tools.

**NOTE:** This system is charged with HFC134a non-ozone depleting refrigerant. Please refer to the **TROUBLESHOOTING AND SERVICE SECTION** of this manual for more details.

## VARIABLE CAPACITY COMPRESSOR WITH LOAD MATCHING

Commencing February 2000, all ADLER/BARBOUR products are equipped with the most advanced DC compressor ever—the Danfoss BD50F. Its wider performance range enables us to precisely match the compressor speed and capacity to the job it must do, while still keeping power consumption to a minimum. This means:

For the largest refrigerators, and for all freezer applications, the compressor operates at maximum 3500 RPM, producing approximately 25% higher performance than previous BD35F compressor.

For mid-sized refrigerators, and for most freezer applications, the compressor operates at 3000 RPM, with about 15% higher performance than previous models.

For smaller refrigerator applications using our VD-150 and VD-151 systems, the compressor will operate at 2500 RPM—still delivering slightly higher performance than previously.

For every application, the BD50F-based ADLER/BARBOUR products deliver top efficiency with minimal power consumption.

## TERMINOLOGY

Below are terms and definitions that will be used throughout this manual:

### CONDENSING UNIT:

The stainless steel base plate mounted compressor, electronic control module, electrical housing and terminal block, refrigerant couplings, air-cooled condenser and shroud (the condensing unit comes precharged with R134a refrigerant). Condensing units may be:

- ColdMachine™ (air-cooled only)
- SuperColdMachine™ (air/water-cooled)

### EVAPORATOR:

Also referred to as “the freezer”, this is the formed aluminum “bin” (or custom-formed “L”, “U”, or “flat”) with connecting tubeset and couplings (also precharged with R134a refrigerant). Mounts inside the space to be refrigerated.

### PowerPlate:

The flat, stainless steel, holdover plate-type evaporator (precharged with R134a refrigerant). Mounts inside the space to be refrigerated.

### Tubeset:

The copper refrigerant tubing and couplings, also precharged with R134a refrigerant. Tubesets may come attached (evaporators) or separate (PowerPlates).

### Thermostatic Control (T’stat):

May be *analog* (knob) type or *digital* (LED display) type.

### Cabinet, Box, Icebox, Compartment:

The insulated space that will be converted into a mechanical refrigerator, freezer, or combination refrigerator/freezer.

### LED:

*Light Emitting Diode*. Mounted in the junction box, used for diagnostics.

### Electronic Module:

The housing attached to the compressor provides complete digital system management.

### Junction Box:

The stainless steel housing with terminal block, LED, T’stat harness socket, fuses and relay.

### ColdMachine™:

The term “ColdMachine” is used throughout this manual when referring to the condensing unit (whether air cooled only or air/water cooled).

## UNPACKING THE EQUIPMENT

When unpacking the unit, carefully check for shipping damage and identify all listed items to ensure that all components have been received and that no in-transit damage has occurred. File claims for loss or damage directly with the carrier. If the system was purchased through a dealer, please contact the dealer directly.

All ADLER/BARBOUR refrigeration systems include the following:

- Condensing unit
- Evaporator assembly (*either* aluminum with integral tube set *or* PowerPlate with separate tube set)
- Ice cube trays, vertical or horizontal to suit: 2 for small evaporators, 3 for large evaporators (trays are not included with PowerPlate systems)
- Separator to retain ice cube trays (vertical style only)
- Thermostatic control (*either* digital with wire harness *or* analog (knob type) with wire harness)
- Installation / small parts package
- Template for evaporator mounting hole locations (except PowerPlate systems)
- Soft-sealing *removable* mastic putty ("Mortite") for tubing exit hole through box (never use the durable marine type)

## TOOLS AND EQUIPMENT NEEDED FOR INSTALLATION

- Electric drill with assorted small bits including 9/64"
- Stubby Phillips screwdriver
- Hole saw 1-1/2" diameter
- Wrench, open end type, 5/8"
- Wrench, open end type, 13/16"
- Wrench, open end type for powerplate, 3/4"
- Electrical wire, 2 conductor, marine type tinned flexible copper stranded (see Wire Size Table in this manual)

\*Alternatively, two (2) adjustable wrenches, 10" size

## PLANNING THE CONDENSING UNIT INSTALLATION

Please keep the following points in mind when planning the installation.

### GENERAL

- The connecting refrigerant tube set between the condensing unit and the freezer is 15' long (12.5' for PowerPlate). Plan the location of the two units accordingly.
- The route of the refrigerant tube set through the boat from the condensing unit to the icebox must be determined before starting any work. The tube set must be kept clear of any bilge water and protected from the chafe and damage.
- Ventilation openings or ventilation duct options will be required if the compressor unit is located in a small, confined compartment. *Re-circulating the same is unacceptable.*
- Engine room location for the air condensing unit is okay if the continuous environment is not over 100°F, but performance will be much improved if a Duct Kit or Power Duct Kit is installed to provide inlet air at under 90°F. *A cooler location = less running time = lower amperage draw.*
- Accessibility is an important consideration.
- All components must be protected from bilge water, spray or possible physical damage.

### VENTILATION REQUIREMENTS

The ColdMachine is a device that moves heat from one place to another. It does not "create cold." The heat removed from your icebox by way of the evaporator is transferred to the air around the condensing unit. If you locate the condensing unit in a small, hot or confined enclosure, it will suffocate. Its built-in fan will have to re-circulate hotter air. It will run continuously, draw excess amps and not cool efficiently. It will never shut off and its performance will be unacceptable.

**Let the unit breathe!** Position the condensing unit so that its fan can intake air from one space and discharge it to another. *Do not re-circulate the same air unless the compartment in which you mount the unit is 100 cubic feet or larger in volume, unobstructed, and mostly below the waterline.*

## DUCT KITS AND POWERDUCT KITS

To achieve cool airflow through your ColdMachine, we offer four different packages to improve ventilation:

### **FOR THE COLDMACHINE:**

---

#### **Part # C8079**

Ventilation Duct Kit with adapter shroud, 3 ft. of 4" flex duct, 1 adapter flange and trim grille. Attaches to the condensing unit with four screws. Can be used in two ways:

- (1) To bring air to the unit from a cooler location—bilge, yacht accommodation, cool ventilated locker, etc., *or*
- (2) The condensing unit's fan can be physically reversed and the duct kit can be used to extract air from the unit and discharge it into another space. This is preferred if the location has cool air available, but has no way to get rid of the warmer air after it has passed through the condensing unit.

#### **Part # C8075**

Power Duct Booster Duct Kit—as above, with 5 feet of 4" flex duct, 3 adapter flanges and additional booster fan. Used exactly like above, plus the longer length and push-pull fans" allow you to go to a greater distance through the boat to pick up cool air or get rid of heated air.

### **FOR THE SUPERCOLDMACHINE:**

---

#### **Part # C8070**

Ventilation Duct Kit with 3 ft of flex duct, 1 adapter flange and trim grille. Attaches to the SuperColdMachine condensing unit with 4 existing fan mount screws. Can be used in 2 ways:

- (1) To bring air to the unit from a cooler location—bilge, yacht accommodation, cool ventilated locker, etc., *or*
- (2) The condensing unit's fan can be physically reversed and the duct kit can be used to extract air from the unit and discharge it into another space. This is preferred if the location has cool air available, but has no way to get rid of the warmer air after it has passed through the condensing unit.

#### **Part # C8071**

Power Duct Booster Duct Kit—as above, with 5 feet of 4" flex duct, 3 adapter flanges and additional booster fan. Used exactly like above, plus the longer length and push-pull fans" allow you to go to a greater distance through the boat to pick up cool air or get rid of heated air.

## LOCATION CONSIDERATIONS

**IMPORTANT:** Find the coolest possible location in the largest compartment available. However, many other locations are acceptable provided the appropriate ventilation duct kit is installed (see below).

### **ENGINE COMPARTMENT**

*DUCT KIT OR POWER DUCT KIT MANDATORY.*

Mount the condensing unit as far as possible from the engine, particularly the hot exhaust pipe sections. Route the connecting tubing from the evaporator away from the hot spots such as the engine, manifold or hot water pipes. If the tubing must be run close enough to local hot spots to become noticeably heated, protect it with insulated sponge tubing ("Armaflex" or similar, available from home improvement outlets).

**IMPORTANT:** The condensing unit must be mounted horizontally, base down. NO EXCEPTIONS. It will tolerate up to 30° off-level but must not be mounted off-level initially.

### **SAIL BIN, LARGE LAZARETTE, OR ANY CLOSED COMPARTMENT**

Generally adequate without ducting, if there is 100 cubic feet of volume and half of the outside surfaces are below the waterline for heat dissipation. In such a case, heat will transfer outside the compartment via conduction. Be sure that airflow into and out of the condenser is not obstructed by sail bags, lines, etc. Position the unit so that it can still move air freely despite an occasionally sail bag or two dropped nearby.

If above conditions cannot be met or if compartment air temperature exceeds 100°F, you **MUST** install a duct kit.

### **UNDER A SETTEE, GALLEY COUNTER, BERTH OR LOCKER (or any space under 100 cubic feet)**

Position the unit so that it can positively draw air from one space and discharge it into another. Simply cutting holes or grilles into the space will not accomplish this.

The best results are achieved by cutting a rectangular opening in the bulkhead equal to the size of the condenser (8" x 8"). Mount the unit with its condenser against the opening for air intake. Provide another opening of at least equal size at the other end (or either side) of the unit so that warm air can exhaust. Small slots or air holes generally are not satisfactory. One big opening is much better. However, if visible finished joinery must be cut into, plan to use teak louvered grilles (available in many stock sizes from teak woodwork and marine hardware catalogs). Increase the size of the outlet opening by at least 1/3 (ie: to about 100 square inches or more) to compensate for the teak louver obstruction.

## MOUNTING THE CONDENSING UNIT

### MOUNTING

**CAUTION: UNIT MUST BE MOUNTED HORIZONTALLY, BASE DOWN.**

Handle the condensing unit carefully. Do not pick it up by the tubing. The cooling fins on the condenser (the radiator-like object) are very thin for maximum efficiency and bend easily. If bent, they should be straightened using the flat blade of a screwdriver or “combed” (using a “fin comb” obtainable at a refrigeration supply house).

Use four (owner-supplied) fasteners to mount the unit on a suitable, sturdy HORIZONTAL platform. Use 1/4” diameter wood screws, self-tapping screws or machine screws and nuts, depending on the type of mounting platform. There are mounting holes in each of the four corners of the condensing unit base for this purpose.

### Bulkhead Mounting Bracket

If this optional part was ordered, it must be **bolted through** the bulkhead selected, not **screwed** to it. Use 1/4” or 5/16” diameter bolts with large flat washer or backup plate on other side. The system is supplied with 4 oversized flat washers. These must be used on the wood or fiberglass bulkhead side—to distribute the bolt loading to the bracket properly.

**NOTE:** The bracket may seem too light and flexible before it is mounted. Once bolted securely to the bulkhead, then use supplied bolts to secure the condensing unit base, it becomes stabilized and very rigid.

## PLANNING THE EVAPORATOR INSTALLATION EVAPORATOR LOCATION CHOICES

### Vertical Applications

Locate the evaporator vertically, as high as possible on any side-wall in the icebox. Template, standoffs (1”) and mounting screws (1-3/4”) are supplied.

Allow sufficient space for access to the freezer interior, insertion and removal of the VertiCube™ ice trays and periodic cleaning.

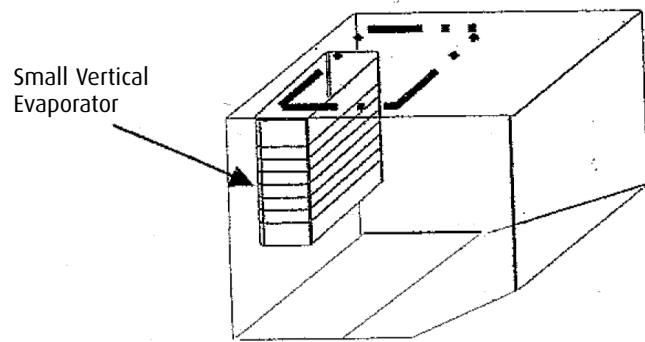

### BASIC REFRIGERATOR UP TO 9 CUBIC FEET

Small vertical evaporator mounted in typical top opening box smaller than 9 cubic feet.

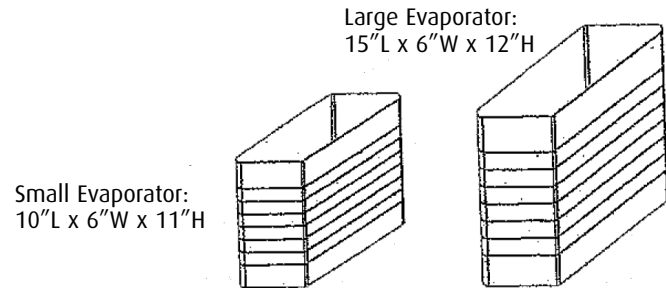

### OPTIONAL BOX MODIFICATIONS AND COMBINATIONS

Freezer/Refrigerators—up to 9 cubic feet total:

In many applications, the Adler/Barbour system has substantial surplus capacity beyond that needed for a refrigerator-only. Therefore, it is often practical to partition the box into two sections if a larger freezer capacity than provided by the evaporator unit itself is desired. The amount of volume allotted to each section will depend on the individual needs and is subject to the system’s capacity.

**A large size evaporator system (VD-152 or VD-153) is best. The small size evaporator systems (VD-150 or VD-151) will generally work only if the total box volume is under 6 cubic feet.**

Some experimentation may be necessary before the location of the partition is finalized. *A minimum of 4" of rigid polyurethane foam insulation is mandatory on all box surfaces for this application. Please do not attempt it with less.* In boxes up to 8 or 9 cubic feet, it is generally possible to obtain 2-3 cubic feet of below-freezing space by creating a suitable partition.

For the partition, use a sheet of 2" rigid polyurethane foam core with fiberglass or Formica faces, tightly fitted and sealed airtight to the box sides and bottom. The necessary materials should be available locally (home improvement outlets) and are relatively easy to work with.

For cool air feed to the refrigerator side, drill a 3" diameter hole halfway up the partition and leave about a 1" gap at the top. This will allow for natural convection airflow from the freezer to the refrigerator section.

You may need to install a manual damper over the hole to better control individual compartment temperatures. This can be a simple disc with a single pivot screw. As an alternative, you can use the Adler/Barbour self-powered, thermostatically controlled Automatic Shutter (Part #D7230). Use one automatic shutter for each four cubic feet of refrigerator space. For the shutter, cut a slot 1-1/8" high x 4" wide instead of a 3" hole.

For side door refrigerators, a Spillover Fan Kit #C7210 is preferred—please see the following section.

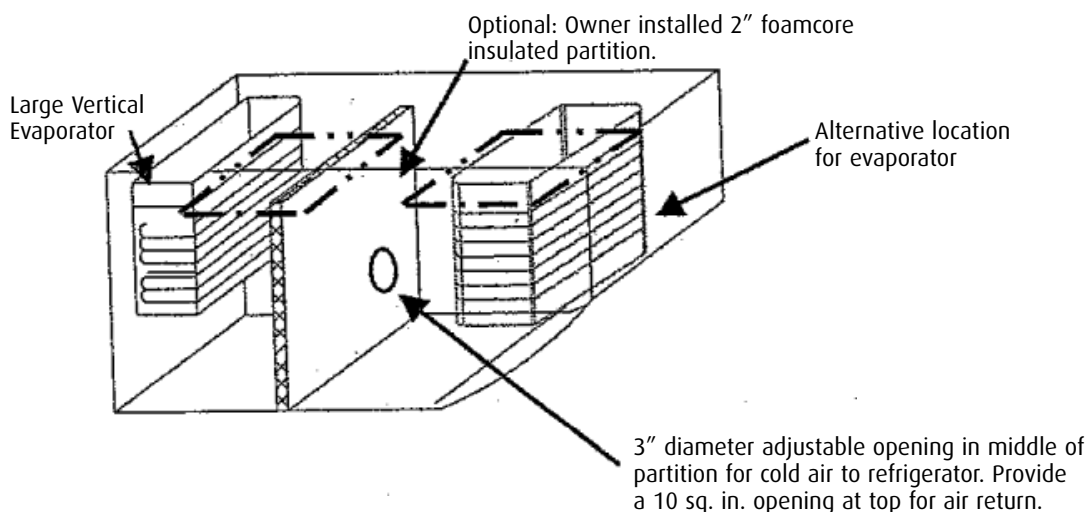



---

## Large Refrigeration or Combination Box—9–15 cubic feet total

### OPTIONS:

- “All Refrigerator” without optional partition: provides ample capacity for 3 ice trays (which are standard) and frozen food, or 9 ice trays only and no frozen food.
- “Divided Refrigerator-Freezer” with customer-installed partition: provides additional freezer capacity (up to approximately 3 cubic feet). Minimum 4" of insulation is mandatory, all surface including lids and countertops.

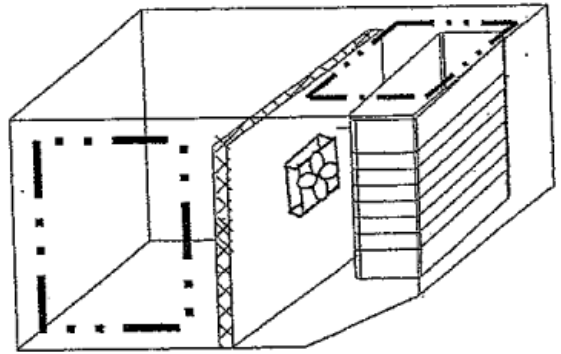
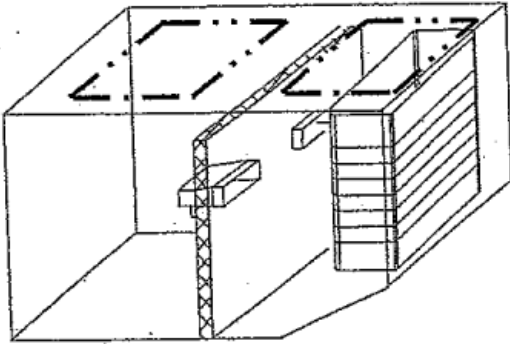
Top opening refrigerator/freezer using one or two #D7230 automatic shutters (one shutter for each 4 cubic foot of refrigerator volume)



Side door refrigerator and top opening freezer using #C7210 spillover fan with thermostatic control.

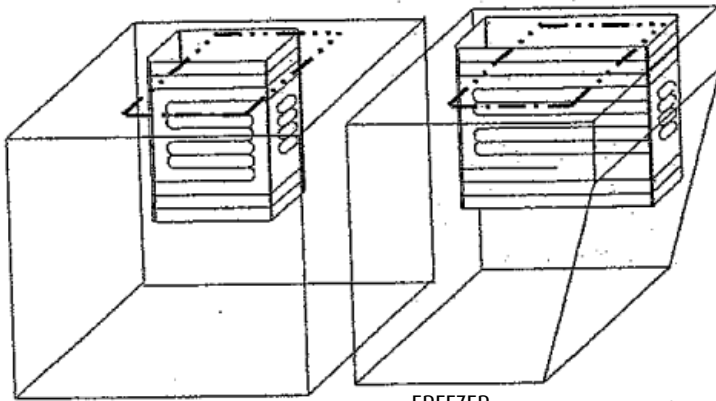

REFRIGERATOR with small vertical evaporator

FREEZER with large vertical evaporator

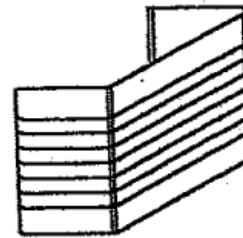

OPTIONAL CUSTOM FORMED EVAPORATOR contact factory for more information

**SEPARATE REFRIGERATOR AND FREEZER USING TWO (2) INDEPENDENT ColdMachine™ SYSTEMS**

Use this arrangement for a single, large, fully partitioned box or for two separate boxes in different locations.

**FREEZER:**

The large evaporator is used for freezer applications up to 6 cubic feet with box insulation 4" or better, 8 cubic feet with insulation of 6" or better.

**REFRIGERATOR:**

The standard small vertical or small horizontal evaporator is used for refrigerators up to 9 cubic feet. The large evaporator is used for refrigerators up to 9–15 cubic feet.

**HORIZONTAL APPLICATIONS:**

Mount the evaporator unit horizontally from the roof of the icebox. Standoffs (1") and mounting screws (1-3/4") are supplied. Allow clearance for the freezer door to swing open.

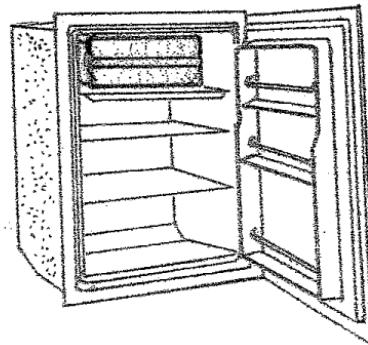



## MOUNTING THE EVAPORATOR

Plan the installation to allow for minimum modification of existing shelving.

- Using the paper template supplied, mark the location of the four mounting holes.
- Position the refrigerant tube exit hole in the icebox for minimum bending and strain on the evaporator and tube set. Mark its location (1-1/2" diameter).
- Drill the mounting holes using a 9/64" drill and the tube set exit hole using a 1-1/2" hole saw.
- Unroll the entire tube set. An assistant is very helpful here. It is often easier to unroll the entire tube set and stretch it outside the boat. Feed the tube set and couplings through the holes in the icebox and bulkheads while an assistant supports the freezer unit and keeps the tubing feeding smoothly without damaging it. **Be careful not to kink, flatten or strain joints.** Make sure the plastic caps are in place over the refrigerant couplings. **Keep dirt out of the couplings.**
- Feed the tube set through the boat to the compressor unit. Do not attempt to connect the mating couplings or remove the plastic caps yet.
- Fasten the freezer unit to the icebox liner with 1-3/4" stainless steel screws and 1" plastic standoffs supplied.
- Position the rubber insulation sleeve on the tube set so that its end is flush with the *inside* of the liner of the icebox with the balance extending *outside*.
- Form excess tubing, if any, into an 18" (approx) diameter coil in the horizontal plane above the compressor unit or at any other convenient location.
- As shown below, seal the icebox hole using the mastic sealant ("Mortite") supplied.

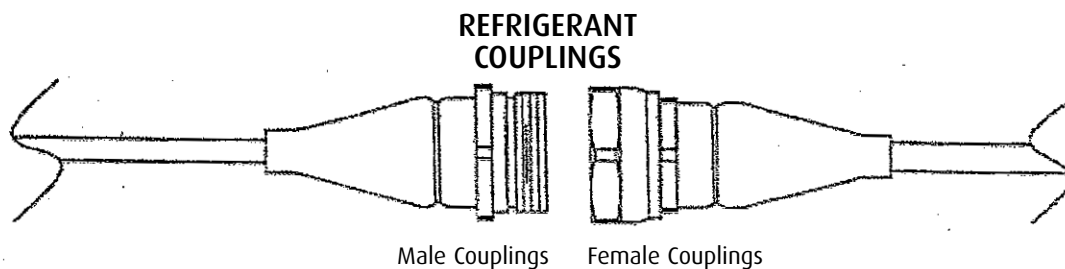
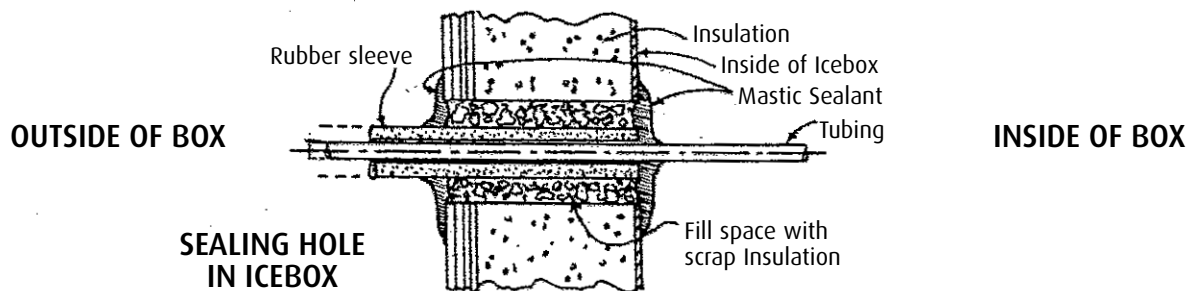

## ALL-METAL PIERCING TYPE COUPLINGS

Once connected, the All-Metal Piercing Type Couplings on this system cannot be disconnected without total loss of the refrigerant charge.

### DESIGN ADVANTAGES:

**NO LEAKS:** Couplings cannot leak prior to connection because both halves are sealed shut by brazed all-metal diaphragms.

**MIX & MATCH:** Each half of your system is precisely charged with refrigerant at the factory. After coupling together, the completed system will have the correct total charge.

**RESULT:** Any Adler/Barbour VD-150 series aluminum evaporator, VD-160 PowerPlate, or VD-170 series blower evaporator can be connected to any CU-100 ColdMachine™ or CU-200 SuperColdMachine™ condensing unit.

**NOTE:** Our 50 Series and 80 Series products each have their own "families" of charge-balanced evaporators. They are not interchangeable with each other or with the ColdMachine™ evaporator family. Nor can a 50 Series or 80 Series condensing unit be used to replace a ColdMachine™ CU-100 or CU-200 condensing unit by coupling it to a ColdMachine™ Series VD-150, VD-160, VD-170 evaporator.

### TOOLS FOR THE ALL-METAL PIERCING TYPE COUPLINGS:

- Use a 5/8" wrench for the male coupling
- Use a 13/16" wrench for the female coupling
- Tighten both couplings to 12–14 ft / lbs. (16.3 to 19.1 newton/meters)

### TOOLS FOR THE TUBE SET CONNECTION TO POWERPLATE:

- Use a 5/8" wrench for the male coupling. Do not loosen the coupling from its brazed-on base.
- Use a 3/4" wrench for the female coupling. Do not loosen the coupling from its brazed-on base.
- Tighten both couplings to 12–15 ft / lbs. (16.3 to 20.3 newton/meters)

### BEFORE CONNECTING

#### Secure tubing and wiring to protect from chafe and vibration.

- Coil the excess tubing and the thermostat wiring harness in an 18" to 24" diameter coil and secure preferably in a horizontal orientation.
- Support the refrigerant tube set and the wire harness using clamps and/or plastic wire ties (4 supplied).
- Keep the tube set and harness out of bilge water and protected from chafe and vibration.

- The tubing must not be allowed to vibrate or chafe.
- Seal the exit hole in the icebox wall using the supplied mastic.

## ALL-METAL PIERCING TYPE REFRIGERANT COUPLINGS AS USED ON ADLER/BARBOUR SYSTEMS COMMENCING JANUARY 2001

### DESIGN & OPERATION

A complete 5780 series coupling consists of the combination of male and female coupling halves. You have the option of choosing either coupling half with or without a charging port, depending on your particular application.

### COUPLING HALVES BEFORE CONNECTION

Diaphragms in the coupling halves provide a seal that prevents refrigerant loss before connection. The male half (right unit) contains a cutter blade, the metal refrigerant sealing diaphragm and intermediate synthetic rubber seal which prevents loss of refrigerant while the coupling is being connected. The female half (left unit) contains a metal diaphragm, which is leakproof metal closure.

### COUPLING HALVES CONNECTED

Tightening the union nut draws the coupling halves together, piercing and folding both metal diaphragms back and opening the fluid passages, thereby providing minimal restriction to flow. When fully coupled, a parent metal seal forms a permanent leakproof joint between the two coupling halves preventing the loss of refrigerant to the atmosphere.

### COUPLING HALVES BEFORE CONNECTION

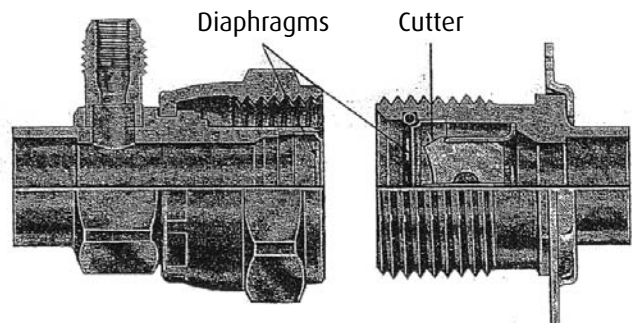

### COUPLING HALVES CONNECTED

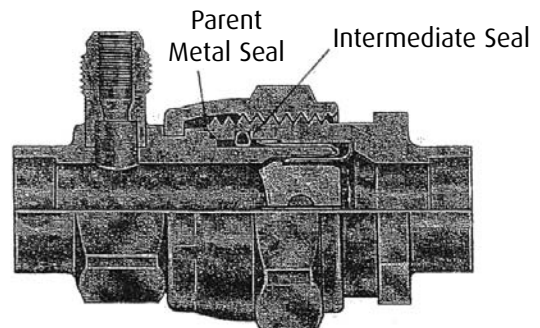

The three illustrations below show you a cutaway view of the male and female coupling halves being joined at 20%, 50% and 100% connection.

**NOTE** the way the cutter blades pierce the diaphragms and fold them back out of the flow path. Also note the difference in the final sealing area before and after torquing.

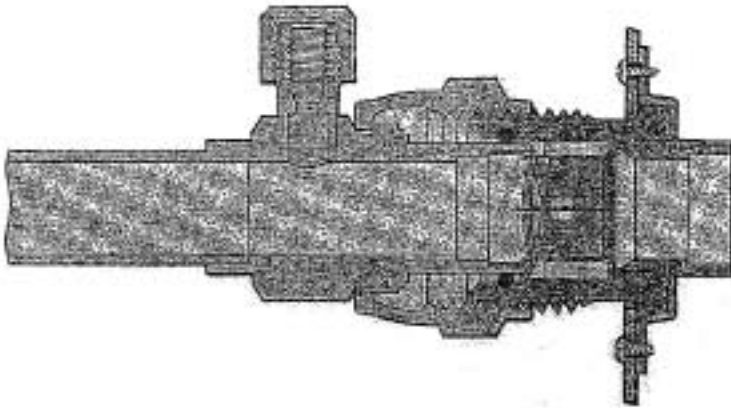

20% Connected

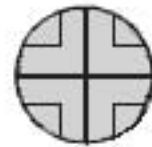
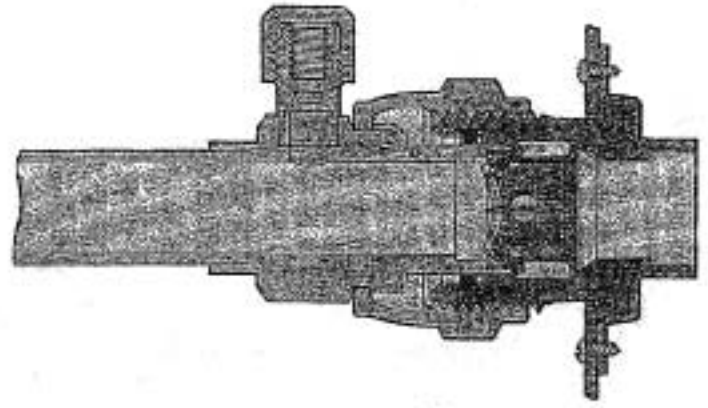

50% Connected

Final Sealing Area connected *prior* to torquing

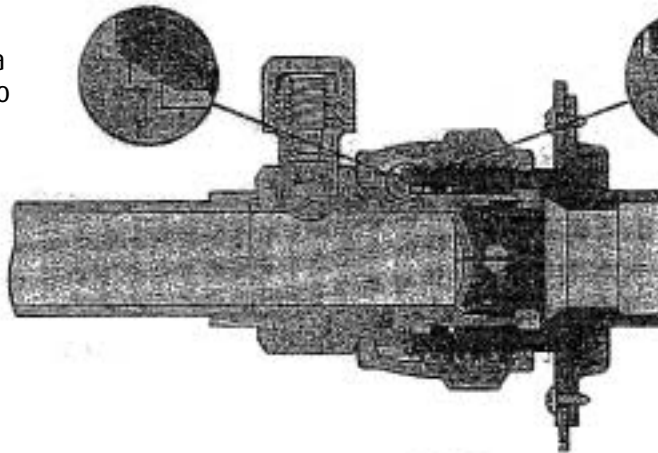

Final Sealing Area connected *after* torquing

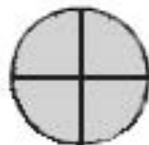

100% Connected

## STEP-BY-STEP: ASSEMBLING THE ONESHOT COUPLINGS

### COUPLINGS MUST BE IMMACULATELY CLEAN

- Leaving plastic caps and plugs in place, carefully wipe off the fittings to remove dirt, dust and moisture. Now remove the plastic caps from the refrigerant couplings on the compressor unit, and from the mating refrigerant couplings at the end of the tube set. **Don't touch the brass hex dome nuts on the side ports of the evaporator couplings! They are there for possible future servicing only.**

### CONNECT THE LOWER REFRIGERANT COUPLING FIRST

- Thread the coupling halves together by hand to ensure proper mating of the threads. When screwing the male and female halves together, align them carefully to avoid strain and cross threading. If you have difficulty aligning the coupling halves properly, it may be necessary to temporarily shift the compressor unit for better alignment.

### TURN ONLY THE FREE-TURNING PART OF THE FEMALE COUPLING

- Do not try to turn the male coupling. Just hold it with your 5/8" wrench. *If the male coupling is twisted from its copper tubing, there will be a refrigerant leak (that is why 2 wrenches must be used).*
- Using the 5/8" wrench on the male coupling body hex and the 13/16" wrench on the female coupling (holding the male coupling hex stationary), tighten (CW/Clockwise) the female until the coupling halves bottom out and strong resistance is felt. **THIS WILL REQUIRE ABOUT 6 FULL TURNS.**
- Work rapidly to minimize any possible escape of refrigerant past the temporary rubber O-ring seal (it is inside the male coupling). Occasionally there may be a slight "hiss" and/or a drop or two of refrigerant oil when making these connections. Don't stop if this happens—just continue until the couplings feel very tight. The final seal is metal-to-metal).

### FINAL TIGHTENING

- **This step must be performed correctly or a permanent leak-proof joint will not be achieved.**
- Using a marker pen, draw a line from the male coupling body to and over the female coupling as a reference. Tighten the female coupling **one more 1/4 turn** while holding the male coupling hex stationary. This 1/4 turn is essential to ensure that the final metal-to-metal seal is completed, forming a permanently leak-proof joint.

### FINAL TORQUE

*Coupling Torque required: 12 to 14 foot pounds (16.3 to 19.1 newton / meters). Imagine a 14 pound weight at the end of a one-foot wrench) EXCEPT for the small PowerPlate-to-tube set couplings which require 10-15 ft lbs. See the PowerPlate section in your manual.*

***If your final 1/4 turn did not require this much torque, your couplings are still loose. TO REPEAT: The 1/4 turn starts after the couplings are already very tight.***

### Now connect the upper set of couplings.

- Same procedure except: the male coupling is held securely by its support bracket, so you do not have to use 2 wrenches.
- Save the plastic caps in the event the unit ever needs to be uninstalled and returned for service.

## INSTALLING THE ANALOG (KNOB TYPE) THERMOSTAT

Mount the thermostatic control unit high in the icebox, away from moisture and spillage. It should also be visible and accessible. It is acceptable to mount the thermostatic control unit outside of the icebox space if you prefer. At least 12" of capillary sensing tube must be inside the box.

The capillary sensing tube is 36" long and must reach from the thermostatic control unit to the clamping plate on the side of the freezer unit. It must be routed along the icebox wall—clear of food, shelving, etc.

The thermostat can be mounted by using either the adhesive backing on the thermostat mounting flanges or the stainless steel mounting screws (supplied).

If using the adhesive backing, the mounting area must be clean and dry. Peel off the protective backing from the adhesive foam on both mounting flanges of the thermostatic control unit, position carefully and press firmly to adhere.

We recommend that you also use the mounting screws by drilling two 9/64" holes through the thermostat flange holes.

## INSTALLATION PROCEDURE (see drawing below).

1. Carefully unroll just enough capillary tubing to reach the metal and plastic clamp plates on the side of the freezer unit. Via this tube, the thermostatic control unit "senses" the temperature of the freezer unit. Bend the last 2 inches back into a "J" shape. Slide the "J" shaped end between the metal and plastic plates and fasten the screws firmly. *Be sure that four inches of tubing are clamped under the metal plate or the thermostatic control unit will not function properly.*
2. Secure the coil and tube against chafing. (Leave the excess capillary tubing coiled). *The tube must not touch the freezer unit at any point except the clamp plates or an erratic control cycle will result.*
3. Uncoil the 21 foot electrical harness from the thermostat and run it alongside the refrigerant tube set to the condensing unit phone jack. Plug this harness into its mating receptacle on the face of the junction box.

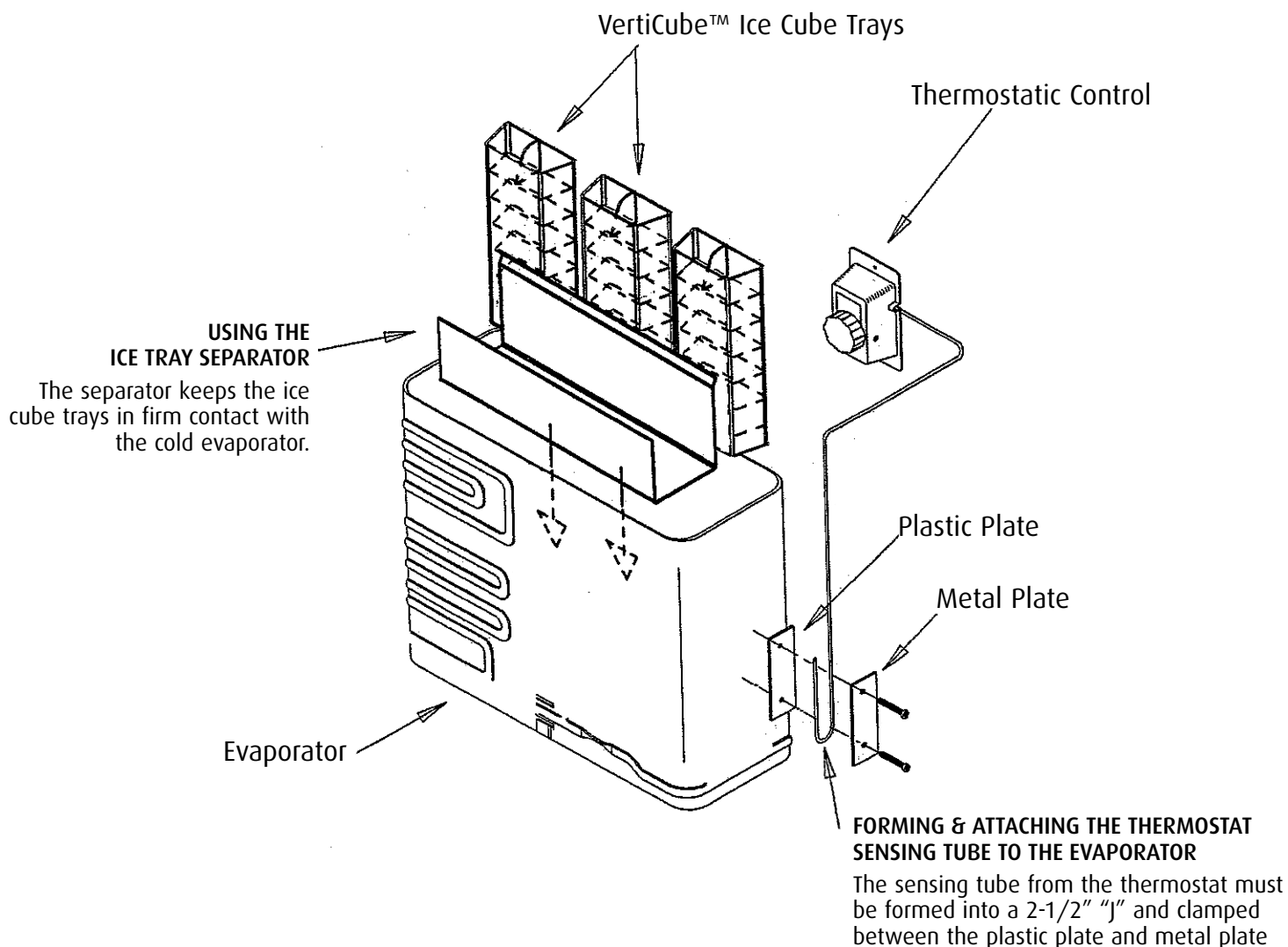

## INSTALLING THE DIGITAL THERMOSTAT

(if supplied)

This optional control has several advanced features, including:

- Touch-pad status indicator for cut-out, cut-in temperatures
- LED relay status indicator
- Temperature setpoint display
- Programmable setpoint and differential
- Large (.56") red LED display

Installing this control is fast and simple. When planning the control location, keep in mind that the sensing bulb wire is 10 feet long.

## MOUNTING THE CONTROL HEAD

1. Make the cutout for the control 3.1" x 1.35" (79mm x 34mm)
2. Snap the control head through the mount faceplate.
3. Mount the faceplate using the four black screws provided.

## MOUNTING THE TEMPERATURE SENSING BULB

1. Run the sensing bulb and wire into the refrigerated box to be controlled. Mount the sensing bulb on a box side wall midway between top and bottom, using the two nylon clamps and screws provided. (NOTE: This is an **air-sensing bulb**, and is not clamped to the evaporator.)
2. Keep the bulb as far away as possible from the evaporator (approximately 2 feet away) and out of the direct airflow if a spillover fan kit is installed.
3. Secure the excess wire to protect it from chafe and damage.

## CONNECT THE CONTROL HEAD TO THE CONDENSING UNIT

1. The digital control has a pre-wired power and signal cable, terminating in a male 4-pin phone plug. This plug mates with the phone jack (socket) located on the face of the electrical box on the condensing unit and marked "T" STAT CONNECTION.

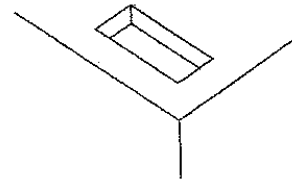
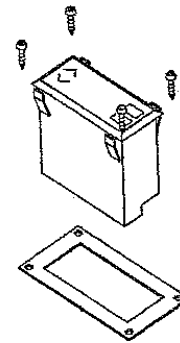
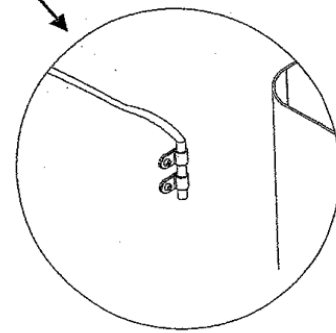
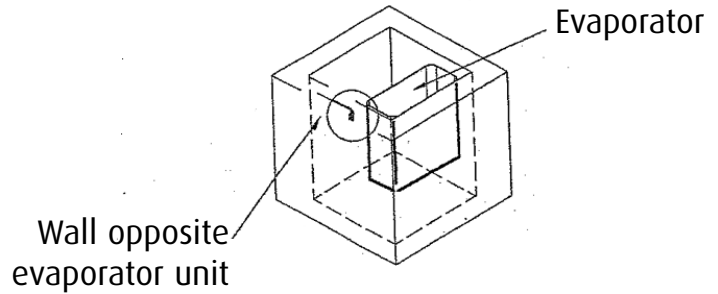
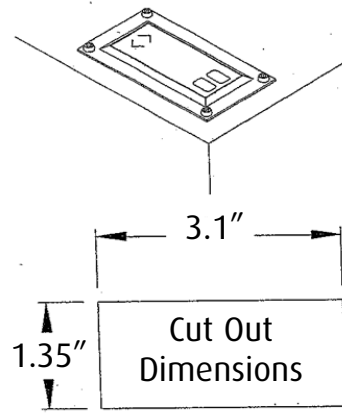

## MOUNTING THE POWERPLATE

1. Plan the installation to position the PowerPlate in the preferred orientation: on a vertical wall of the refrigerator (or freezer) cabinet with the label on top. In this position, the PowerPlate will perform at maximum efficiency. If this is not possible, it may be installed in any spatial orientation; but a small reduction of efficiency may result.
2. Position the PowerPlate high in the compartment—within 2 inches of the top for best results.
3. Be sure to leave room for mating and tightening the couplings that connect the PowerPlate to the tube set.
4. Mark and drill four (4) mounting holes using a 9/64" drill and a tube exit hole using a 1-1/2" hole saw.
5. Be sure to use the supplied four (4) plastic spacers to ensure that the PowerPlate is spaced away from the cabinet wall to permit air circulation behind it for best efficiency. Do not mount the PowerPlate flush against the wall as a major loss of performance will result.

### POWER PLATE TUBE SET

Drill a 1-1/2" diameter hole through the cabinet wall for the tube set. Unroll the tube set. Feed the end with the couplings into the box. Do not remove the protective caps yet.

Position the insulating sleeving **OUTSIDE** (*not inside*) the refrigerated space. The end of the sleeve should butt against the outside wall of the box (you will be sealing this joint later with mastic putty included in your kit.)

Route the service port coupling ends of the tube set through the boat to the condensing unit. Do not remove the protective caps yet.

Before you connect the refrigerant couplings to the power plate, refer back to the section entitled "Refrigerant Couplings" for additional information. Have the required 5/8 and 3/4 wrenches at hand now. Do not allow any dirt, sawdust, foam insulation dust, etc., to get into couplings ends as this will seriously damage the system.

These couplings are different from the couplings that join the tube set to the condensing unit. The small couplings are screwed, o-ringed, and *Loctite*-sealed to the bases that are in-turn soldered to the copper tubes. Therefore, it is most important that you do not unscrew the small couplings from their bases. **Put your wrenches on the coupling bodies only!**

### SMALL COUPLING TORQUE REQUIRED

12–15 foot pounds (less than the large couplings)

### CONNECTING THE PLATE COUPLINGS (from tube set to PowerPlate)

1. Remove the protective caps of one mating pair of the couplings inside the box (start with *either* pair). Screw the couplings halves together until they bottom metal-to-metal with very firm pressure (about 4 turns) using two wrenches: 5/8" and 3/4".
2. Mark the coupling halves. Using your two wrenches (do not use pliers, visegrips, etc) tighten couplings an additional one flat (1/6 turn). This should require considerable wrench torque. If it did not, you did not "bottom" the couplings first.
3. Repeat the above for the other pair of coupling halves.

**IMPORTANT:** Save all coupling protective caps. Put them in a marked container and keep aboard. If a future service procedure requires that any coupling pair be disconnected, these caps must be re-installed immediately to keep out dirt.

To connect the couplings to condensing unit, please refer to section entitled "Refrigerant Couplings." After completing this section, seal the black rubber insulating sleeve to the outside of the refrigerated box airtight, using *Mortite* or other (removable-type) caulking sealant. All three (3) feet of sleeve must be outside the box. This sleeve may butt against the outer wall or the inner liner.

Excess tubing: Form a coil about 18" in diameter, (taking care not to deform the tubes) in the horizontal orientation if possible, and secure tightly to the bulkheads, etc. using plastic wire straps. Protect tubing from chafe and vibration with soft sleeving as necessary.

## ELECTRICAL CONSIDERATIONS

### WATER COOLED OPTION PACKAGE: *How it works and why*

To get absolutely top performance from your SuperColdMachine, you can add this package at any time in the future if not with your original installation. If inlet air temperature to the SuperColdMachine exceeds 90°F, switching to water cool mode will produce shorter “on” times and lower average amp draw. As air temperature increases, the water-cooled advantage increases. In tropical conditions, the total daily power consumption can be reduced by 25—40%.

When you select “water pump on” using the switch panel provided with this option, note that the built-in fan (and the Powerduct fan, if fitted) continues to run. This ensures a flow of air over the compressor to keep it relatively cool and is normal.

It is strongly recommended that you switch the pump off while using dockside power. With the battery charger working, it is more important to extend the life of the water pump than it is to save battery power.

*Example:* You left the boat on Sunday night, plugged in, freezer full of food, and left the water pump on. On Wednesday, a plastic bag gets sucked into the pump intake. The pump runs dry, its impeller shaft locks up, the pump motor stalls. The result is a damaged pump bearing requiring replacement (available from WAECO USA). The “pump / fan” fuse may or may not blow. If it does, the frozen food may be lost because the unit may shut down to protect itself. It is important to shut off the pump when you leave.



# WATER COOLED OPTION INSTALLATION

Please refer to the diagrams below.

Basic rules for a good installation.

1. The pump must be at least 1 foot below waterline at all times (regardless of which tack you are on).
2. The pump orientation must be as pictured—no other positions will work.
3. The strainer should be mounted with the bowl pointing downward, otherwise, it will trap air and possibly airlock the water pump.
4. Inlet thruhull must not be “shared” with any power-driven pump and absolutely not the engine’s intake! you may “tee-off” a toilet inlet, cockpit drain, galley seawater foot-pump line, etc., provided that the seacock is at least 2” below the waterline.
5. Inlet thruhull must have a “scoop” facing forward on the outside of the hull to prevent “back siphoning.” At high sailing speeds, the flow direction may reverse, introducing air into the pump and damaging it. Failure to provide this scoop is the major cause of pump failures.
6. Heeling can obviously be a problem since the pump may be well below the waterline at rest or on one tack, but not on the other. Traps and airlocks may also be created when the boat is heeling. In most cases, the positive “ram effect” created by the outside hull inlet scoop will overcome these problems. This is another reason why the scoop is so important.
7. Overboard thruhull (supplied) must be above the waterline—so you can verify pump operation.
8. Total hose length must not exceed the 15 feet furnished.
9. Total lift (example: highest point of piping above pump) must no exceed 5 feet.
10. No “traps” allowed! This means no “dips” in hoses. They must run level or steadily uphill from inlet to strainer to pump to highest point. To simplify, if you picked the boat up in slings, the entire water circuit (except for strainer contents) must drain through the inlet thruhull.

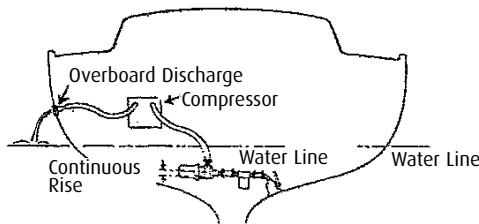

**Preferred Arrangement**

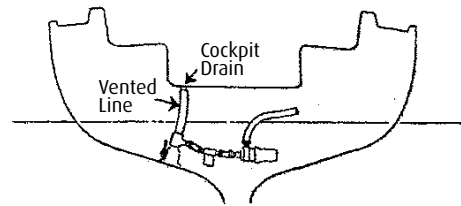

**Acceptable Arrangement**

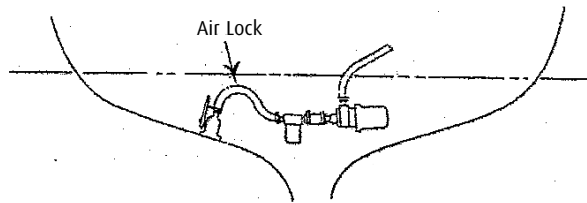

**UNacceptable Alignment**

**NO OTHER POSITIONS ARE PERMITTED!**

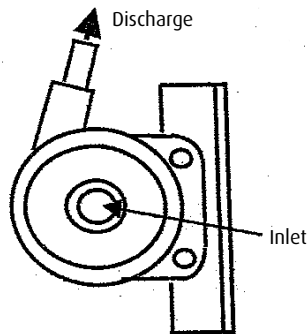

**Base Vertical Discharge Points UP**

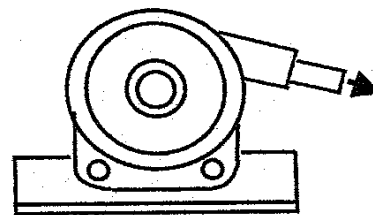

**Base Horizontal Discharge is approx. Horizontal**

## BATTERY RECOMMENDATIONS

A minimum of THREE marine-grade batteries are strongly recommended: One exclusively for engine starting and the other two as a single bank for all other DC electrical devices such as lights, electronics and your system. The second battery or group of batteries (wired in series or parallel depending on voltage) is commonly called the "house bank." A standard marine battery selector switch should be installed to isolate each battery or battery bank.

The house bank should be at least 300 amp/hour capacity. More is desirable. The larger the battery bank, the longer you can operate the various loads between engine charging and the faster you can recharge. This is because the alternator actual output in amps is greater into a larger battery bank. Experts suggest the bank's nominal amp/hour rating should be four times (4x) the alternator's rated (hot) output.

The following ampere/hour capabilities are recommended for the house bank, which serves the ColdMachine™.

**For the "casual cruiser" 25-35 feet, seldom away from dock for longer than overnight ...minimum 200 amp/hours**

**For the "serious cruiser" 30-50 feet, often cruising for a week or more ...minimum 300 amp/hours**

**For the charter yacht or tropics-based "serious cruiser" operating in hot climates and requiring greater quantities of ice cubes and frozen foods .... Minimum 400 amp/hours.**

### **High Output Alternator, Electrical Management Systems, and Batteries**

The continuing proliferation of electrical and electronic devices aboard boats has produced great interest in reducing engine-running time required for battery charging. Specialty high-output alternators are readily available. Several manufacturers offer complete electrical generation and management systems. It is now entirely practical for medium sized cruising boats to support DC refrigeration, inverter-driven galley appliances, navigational systems including computerized charting and radars, all with very acceptable daily engine hours for battery charging.

As to batteries, a good deal of misinformation still exists regarding "marine," "deep-cycle" and "deep-discharge" batteries. These terms generally describe a battery constructed to provide small-to-moderate currents for long periods of time, as opposed to short bursts of high current to start engines. While "deep-cycle" batteries start engines quite satisfactorily, engine-starting batteries are very poor for small current, long-term tasks. Automotive, sealed, or so-called "maintenance-free" wet-type batteries are okay for the engine start battery, but are not suitable for the house or service battery bank that runs all the other equipment on your boat *regardless of how they are labeled*. A

few manufacturers of genuine, marine, heavy-duty, deep cycle wet-type batteries are creating a public awareness of the inadequacies of disguised, re-labeled automotive batteries for marine use, particularly as house batteries in sailing yachts.

**GEL and AGM Batteries** (as distinguished from so-called "maintenance free" auto batteries): Several high quality products are available in all popular sizes. They perform comparably to the very best wet-type deep cycle traditional batteries, but require little or no maintenance. However they require very carefully regulated charging systems, and cannot be simply interchanged with wet batteries.

What all this means is that a boat owner with a full complement of equipment aboard such as electronics, refrigeration, auto-pilot, stereo, etc and who feels the engine must be run too long for battery charging, can get very substantial improvements by using the technology and equipment now available.

We strongly urge all boat owners to take advantage of the excellent technical manuals, articles and products now available in the marine industry. There is no longer any reason to put up with long hours of engine running and marginal electrical systems.

## WIRING THE SYSTEM

All Adler/Barbour products from December 1998 forward incorporate a new, more powerful and more energy efficient compressor featuring a 3-phase AC motor, which is driven and **digitally** managed by the **electronic module** (the finned device on the side of the compressor).

NOTE: The electronic module is not repairable, should not be opened and must be replaced if damaged.

This control unit, like most electrical devices, requires fairly "clean" DC current for stable operation and long service life. Batteries provide clean, ripple-free DC current. Many battery chargers, alternators and AC/DC converters may not. This means that the ColdMachine should not be connected directly to any of these devices, unless a battery is between them in the circuit.

## VOLTAGE DROPS

When in the starting mode, the ColdMachine may momentarily draw nearly 10 amps, even though the continuous running current is between 3 and 5 amps. If the electronic control module does not “see” at least 11.0V DC during the start period, it will abort. Therefore, to avoid erratic problems, the supply wiring must be correctly sized—please see Wire Size Table.

### Make your wiring connection in one of these three ways:

1. Directly to the battery via a 15A breaker (recommended). (\*) See note.
2. To a heavy output terminal on the battery selector switch, via a 15A breaker (recommended).
3. To the ship’s distribution breaker panel. This method is acceptable if the selected breaker is directly re-wired to the main battery selector switch with *its own heavy wire*. If not directly re-wired, the voltage drops within the panel will be excessive and cause erratic operation.

Use the shortest possible route for wiring between the unit and battery to avoid voltage drops.

Install a 15 amp circuit breaker in the positive leg for line protection. The circuit breaker is also necessary for long “off” periods because even with the thermostat off, there is still a milli-amp range current flow in the system.

Make sure that all wiring conforms to applicable safety regulations. Note that a replaceable 15 amp fuse located on the condensing unit provides backup protection in case the breaker should fail in the shorted condition.

Use marine quality connectors and circuit breaker to prevent voltage drops in the supply circuit to the ColdMachine. Also, do not install voltage dropping devices such as indicator lights, volt and amp meters, etc., in the 12 volt DC wiring circuit.

Correct polarity is critical. If you connect in reverse, the system will not operate. Should this occur, correct your wiring. The system will automatically re-start.

(\*) **NOTE:** The main fuse on the CM or SCM junction box is 15 amp. WAECO calls for a 15 amp breaker in the (+) DC supply for several reasons:

1. The breaker will generally trip before the fuse will blow, thus saving a crawl through the bilge.
2. The installer may use an incorrect higher-rated breaker, so the 15A fuse will still provide proper circuit protection.
3. In very hot ambient temperatures, the largest systems may briefly draw more than 10 amps for a few seconds, resulting in nuisance trips if a 10A breaker is fitted.

## MAKING THE POWER CONNECTIONS

Use color-coded wire so you know which is positive (+) and which is negative (-). Connect the positive wire to the (+) screw on the terminal strip. Contact the (-) terminal screw to the negative lead to the battery, or the main negative terminal or busbar.

### WIRE SIZE

Wire size is critical. If you use undersized wire, your system will run erratically, often fail to start, produce unsatisfactory cooling and fail early in its service life. Use a wire gauge size based on the total distance from the compressor unit to the battery selector switch.

## WIRE SIZE TABLE

Maximum distance from compressor unit to battery	Gauge AWG
4' and under	#14
5' to 10'	#12
11' to 17'	#10
18' to 27'	#8*
28' to 35'	#6*
36' to 50'	#4*

\*The terminal block on the junction box will accept #10 AWG wire maximum. If you need to run heavier wiring, you should terminate it at a suitable-sized heavy terminal strip and run #10 AWG from there to your condensing unit.

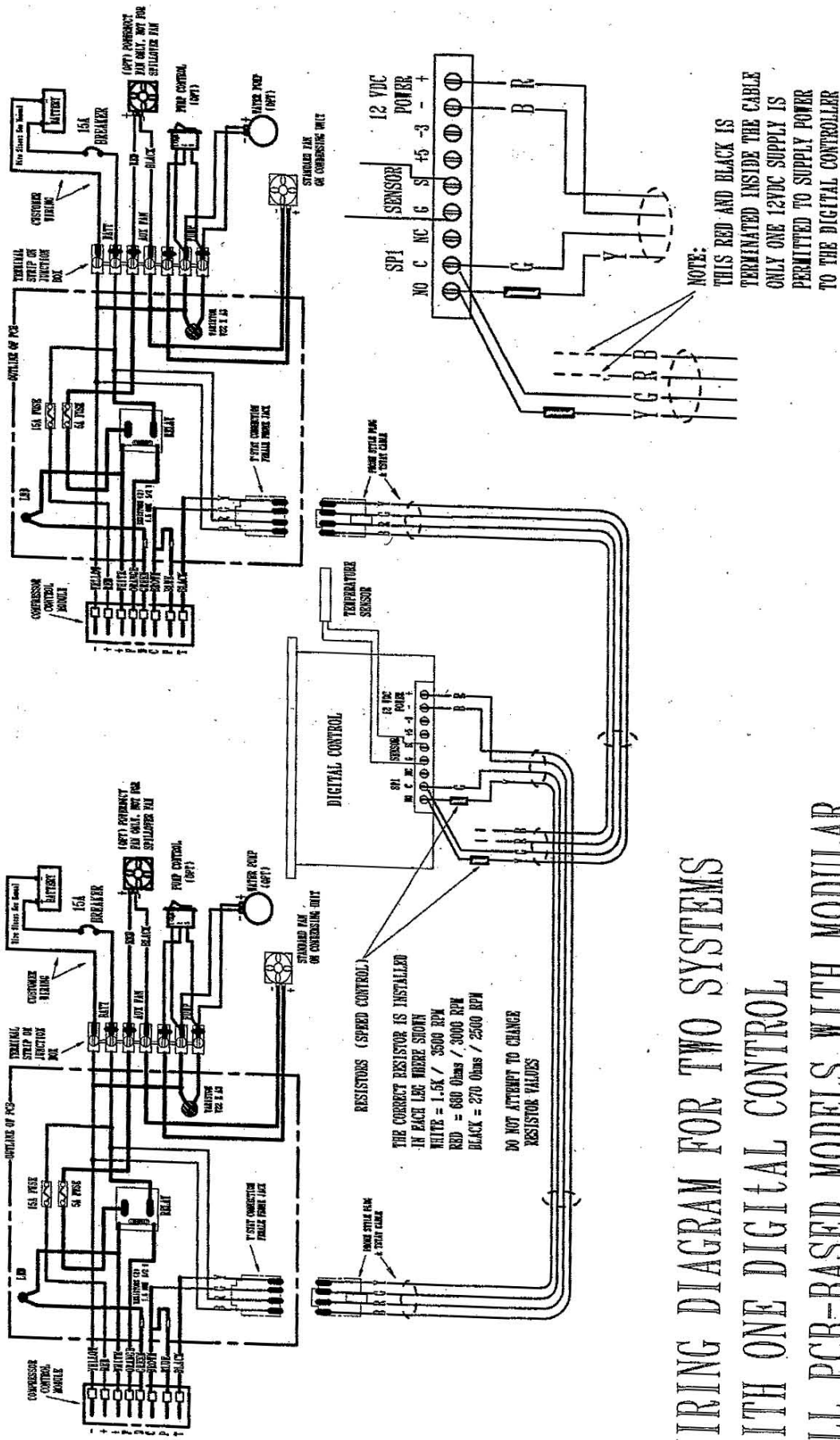

**WIRING DIAGRAM FOR TWO SYSTEMS  
WITH ONE DIGITAL CONTROL  
ALL PCB-BASED MODELS WITH MODULAR  
(PHONE TYPE) CONNECTOR**

used as "terminal" is not an  
LIST 200 2-20-90



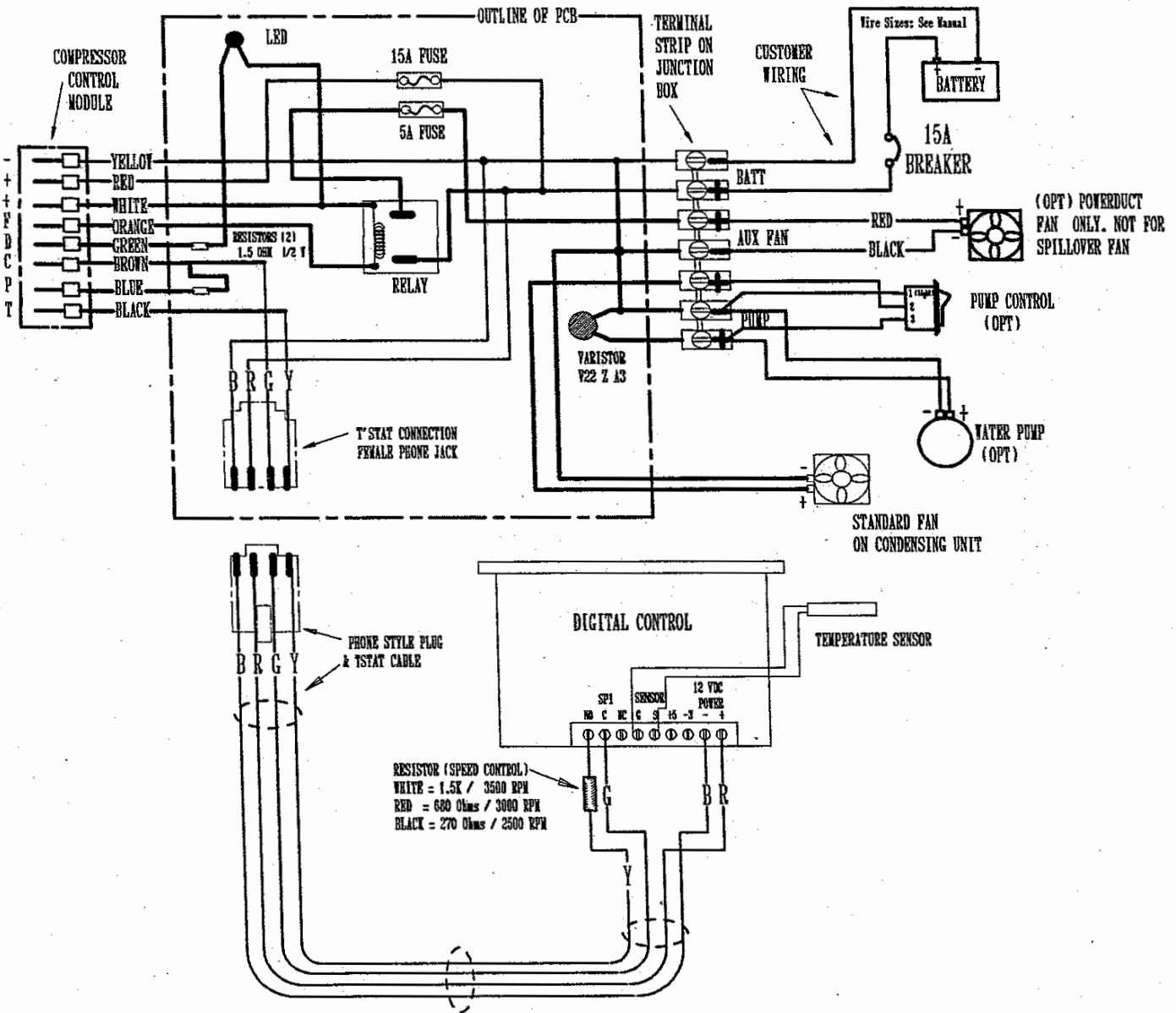

saved as "PCB01G" in rev AB  
 Last update: 3-30-00 RMA

# DIGITAL CONTROL WIRING DIAGRAM FOR SUPERCOLDMACHINE AND ULTRACOLDMACHINE ALL PCB-BASED MODELS WITH MODULAR (PHONE TYPE) THERMOSTAT CONNECTION

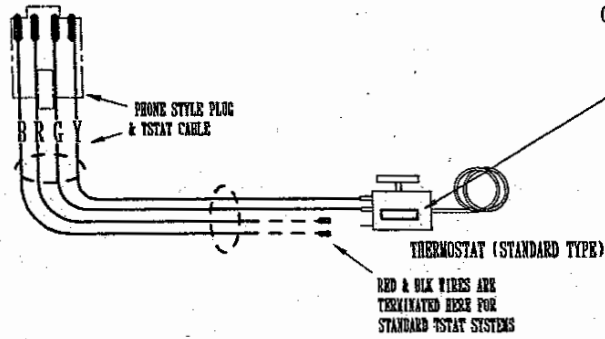
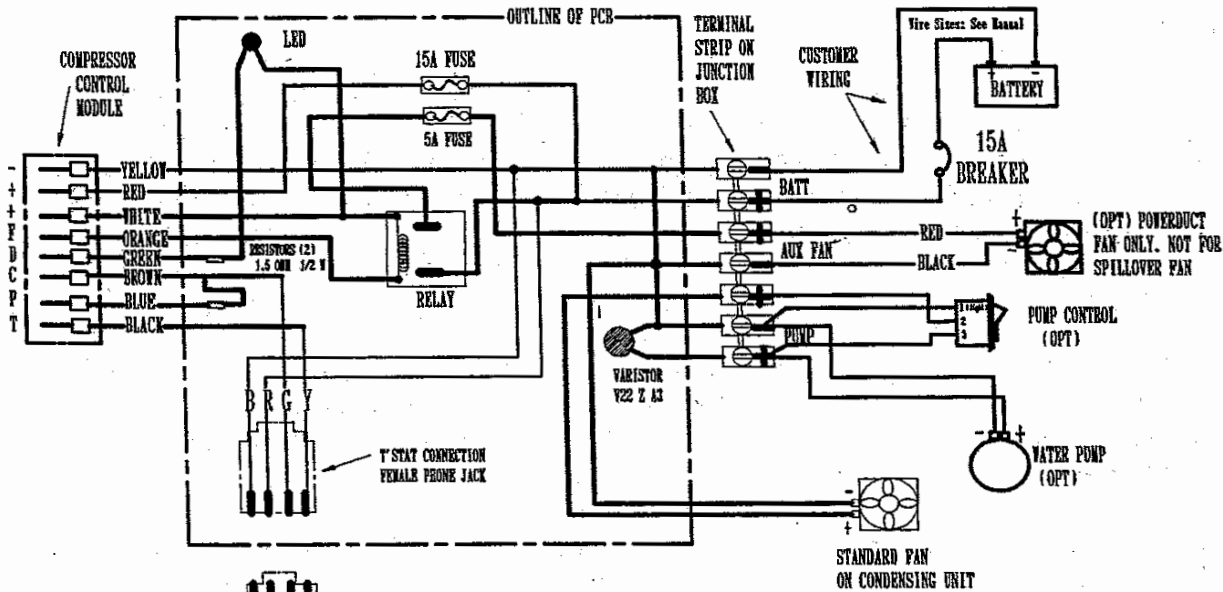

**SPEED CONTROL RESISTOR LABEL**

- C1502JR = FREEZER RANGE CONTROL
- F1710JR = REFRIGERATOR RANGE CONTROL
- 270 ohm (black) = 2500 RPM
- 680 ohm (red) = 3000 RPM
- 1500 ohm (white) = 3500 RPM
- TSTAT ASSYS ARE SHIPPED WITH CORRECT RESISTOR FOR EACH SYSTEM.
- DO NOT ATTEMPT TO REPLACE WITH DIFFERENT TSTAT

ANALOG (KNOB TYPE) THERMOSTAT CONTROL  
 WIRING FOR COLDMACHINE & SUPERCOLDMACHINE.  
 COVERS ALL PCB-BASED PRODUCTS  
 WITH MODULAR (PHONE TYPE) CONNECTOR

saved as "SCHEMPCB" in new AB  
 LAST REV 3-30-00 EMA

# OPERATION OF SYSTEM

## START UP

Turn the thermostatic control clockwise to about #2 or #3, (#1 on the thermostatic control is the warmest setting.....#7 is the coldest)

The ColdMachine system will now start. Within a few minutes, the evaporator will begin to frost (note that a PowerPlate will take much longer before frost is visible on the surface). The system will operate continuously until the box cabinet and contents have been brought to the selected temperature. The system will then cycle off, and thereafter cycle on and off—maintaining proper temperature (similar to a home refrigerator).

## AC/DC OPERATION

The ColdMachine will also operate automatically at dockside with the addition of a battery charger. We recommend a quality MARINE battery charger (not an automotive charger) of sufficient size to handle your ColdMachine along with the other onboard DC loads (such as lights, stereo and electronics).

For the ColdMachine, figure approximately 5 amps when running. The average draw, as the ColdMachine cycles on and off, is 1.8 to 2.4 amps for most 4 to 8 cubic foot iceboxes with average (3 inch plus) rigid polyurethane foam insulation.

## MAINTENANCE

Regular or seasonal maintenance is normally not needed, nor is maintenance required for winter storage or decommissioning. However, you should wash the evaporator occasionally and again before winter storage (use a mild detergent such as *Joy* or *Ivory*). In addition, the air condenser (the radiator-like object in the condensing unit) can get clogged with dirt and should be carefully vacuumed seasonally with a soft brush attachment. Be careful not to bend the cooling fins. If a water-cooled option kit is installed, the water circuit must be drained or filled with anti-freeze solution.

## DEFROSTING

Defrost your refrigerator when frost gets over 1/4" thick. This should not occur in less than a month or so. Excessively fast or thick frost formation is an indication of moist, outside air entering through a poorly-sealed lid, doors or liner joints. These conditions must be eliminated for proper performance.

The best way to defrost is to turn the power off. Open the icebox lid or door and allow sufficient time for the freezer unit to defrost naturally. *Never use an icepick, knife or other metal object—you could pierce the refrigerant coils.*

## BATTERY CARE

Batteries are one of the most neglected and abused items on boats. Unlike automobiles, boat engines run slowly and infrequently. The batteries tend to be buried in the bilge, are damp, dirty and chronically undercharged. Boat wiring is subject to corrosion at various connections, which creates voltage drops as we add more electrical devices each season. As these electrical loads grow, it becomes even more important that you keep your battery and charging system at top efficiency.

In addition, batteries can be deceptive. They may look good and read normal voltage, but may have deteriorated internally and be unable to deliver adequate power for more than short periods of time.

## WET TYPE BATTERIES

Check you batteries at least every month with a hydrometer (inexpensive and available from automotive supply stores). The readings of each cell should be approximately the same. If one reading is lower than the other, it indicates a defective battery. Use distilled water only.

## EQUALIZING (WET TYPE BATTERIES ONLY)

During periodic equalizing, the battery voltage can exceed 15 or even 16 volts. ***To prevent possible damage to your unit, shut the Adler/Barbour system off before starting the equalizing process.***

## ALL BATTERIES

Check your batteries seasonally with a "battery load tester" (obtain from a boatyard or mechanic). This tests the battery's condition and capacity under a heavy actual load.

If your batteries do not pass these test, *replace them*. You are just wasting valuable fuel, engine hours and time in trying to charge them. Observing the following points can add to the dependability and operational life of your battery:

- Keep the tops of the batteries clean and dry. A damp battery can lose 20% of its charge in a day.
- Keep the battery post clamps tight, clean and free from corrosion.



## WINTER OPERATION

If ambient temperatures drop below 35°F in the operational area of the condensing unit, it may be necessary to block off half of the air condenser face area (on the side opposite the condenser fan motor) with a piece of cardboard to maintain system efficiency. The cardboard can simply be taped in place for the winter season and removed in the spring when seasonal temperatures return to above 35°F.

## PROGRAMMING DIGITAL CONTROL

*(if supplied with your system)*

The digital thermostat is pre-programmed at the factory. If settings have to be changed, the following information will allow you to easily program the controller.

- **SET POINT (SP)** This is the desired temperature of the refrigerator. It is pre-programmed at the factory to a temperature range of 35–45°F (0–20°F for freezer).

### TO PROGRAM SET POINT (SP1)

1. To start the programming sequence, press the SET button once. Unit displays "SP1" (set point 1)
2. Press the SET button again to display SP1 value.
3. To program an increase or decrease in SP1, press the appropriate ADJUST arrow.
4. To complete the programming sequence, press the SET button until the screen goes blank. After five seconds, the unit will automatically display sensor temperature.

- **DIFFERENTIAL (dF)** This is the difference between the cut-in and cut-out temperature of the thermostat. The differential must be a negative value. If it is set as a positive value, the relay in the thermostat will close on temperature fall and open on temperature rise. In other words, it will respond as a heating thermostat instead of a cooling thermostat. *Do not set a positive differential. Do not set a differential of 0 (zero).*

- **HIGH & LOW SET POINT LIMITS (HI & LO)** Allow you to limit the range at which temperature set points can be programmed. This is factory set and should not need to be adjusted, unless changing from refrigerator to freezer or vice versa..

### TO PROGRAM DIFFERENTIAL (dF) (HI) AND (LO) POINTS

*Should only be adjusted if necessary. To start the process, you must press the hidden button located behind the "F" symbol at the upper right corner of the control to program these settings. After programming, you must press the "F" button until the screen goes blank.*

1. Press "F" once. "DF1" will appear on the screen. Press "F" again. A negative value will appear. Use the appropriate "ADJUST" arrow to change this setting.
2. This event must be set to a negative value but should not be lower than -5 to avoid short-cycling.
3. Press the "F" button again. The screen will read "HI". Press "F" again and you will read a value. This is the high setpoint limit. It prevents the control from being tampered with and raised any higher than this point. Now you can press the "ADJUST" arrows to get to your desired setpoint.
4. Press the "F" button again. The screen will display "LO". Press the "F" and you will read the LO setpoint limit. Use the "ADJUST" arrows to change it.
5. Pressing the "F" button again will display "CAL". Press "F" again and you should see 00. This should never be changed. If "CAL" reads any value either than 00, use the "ADJUST" arrows until it reads 00.
6. Press the "F" button again. You will see a blank screen. The reprogramming has been accepted and the control will now revert to the box temperature display mode.

**NOTE:** *If the programming sequence is interrupted for more than 15 seconds or not set to the blank screen, the thermostat will revert to temperature display without acknowledging any new inputs.*

- **CALIBRATION (CAL)** Factory calibrated to a certified standard.  
**Do not alter or change.**

## ELECTRONIC MODULE SYSTEM MANAGEMENT AND PROTECTION

The ColdMachine is designed for nominal 12 volt DC operating. The normal operating range is 10.0 volts —15.0 volts. The electronic module will automatically shut off the system if voltage at the module input terminal falls below 10.0 volts. As the battery recharges, the electronic module will automatically turn the system on when the voltage reaches 11.1 volts. This circuitry protects the battery from the damaging effects of a complete discharge and also protects the ColdMachine from chronic low voltage operation.

### MANAGEMENT FUNCTIONS INCLUDE:

- High and low voltage protection (10.0 V DC to 17.0 V DC ) (\*) NOTE
- Reverse polarity protections (compressor will not operate)
- High temperature cutout if electronic unit is overheated
- Overload protection if compressor is dangerously overloaded (by overcharging or extreme high temperature)
- Automatic start abort if the compressor motor cannot rotate
- Battery protection: Low voltage cut out prevents total battery discharge or drain
- Fan relay circuit protection (0.5 amp max; overcurrent will cause system to shut down)
- LED diagnostics

**(\*) NOTE:** *If voltage reaches 17.0 V DC, the module “thinks” it is a 24 V DC system suffering from low voltage, and LED will display one flash. The module will probably survive. The fan(s) and pump (optional) may not.*

## OPERATIONAL ERRORS INDICATED BY THE FLASHING LED ON THE CONDENSING UNIT

If the electronic module “senses” a malfunction, it will automatically switch into its protective mode and will make repeated start attempts at about 1 minute intervals.

### (1) FLASH

Low Voltage Supply. If the supply voltage measured at the upper (-) and (+) terminals of the electronic module drops below 10.0 V DC, the system will shut down. It will not restart until 11.1 V DC is maintained throughout the momentary high-current start attempt.

### (2) FLASHES

Relay Coil Circuit Overload. The relay coil and/or its wiring is shorted. The electronic module shuts off the output current that drives the coil. The fan(s) and water pump (optional) will not operate. (\*)

### (3) FLASHES

Compressor Motor Starting Problem. The motor rotor (armature) is mechanically blocked or stuck or the differential pressure inside the compressor is too high and the motor cannot start.

### (4) FLASHES

Under-speed Compressor Motor Problem. If the compressor cannot reach or maintain its minimum speed of 1800 RPM (due to poor condenser air flow, overcharge, air in the system, extremely hot ambient temperature), it will automatically shut down.

### (5) FLASHES

Electronic Overload. The electronic module is overheated and/or the system has been heavily overloaded (by very high ambients, fan and/or pump failure, air in the refrigerant circuit, and/or refrigerant overcharge).

If the system displays any unusual symptoms, runs continuously or does not cool properly, please refer to the Trouble shooting guide.

**(\*) NOTE:** *Do not operate the system longer than 10 minutes without the fan running.*

For further assistance, please contact  
**WAECO USA’S**  
**TECHNICAL ASSISTANCE DEPARTMENT**  
Monday through Friday  
8am to 5pm EST  
Tel: (860) 664-4911  
Fax: (860) 664-4912

# TROUBLESHOOTING

LED BLINK CODE	SYMPTOM	TEST / DIAGNOSIS	CORRECTIVE ACTION	
	<b>Compressor and fan do not attempt to start</b>	No power to unit / Blown fuse	Replace MAIN fuse (15 amp). Correct wiring refer to manual	
		Reverse polarity	Correct polarity	
3		Pressure too high	Wait, try again	
3		Faulty electronic module Faulty compressor	Replace module Call WAECO USA (860.664-4911)	
2		Faulty / shorted delay	Replace PCB inside stainless steel electrical box	
1	<b>Compressor and fan attempt to start as shown by momentary voltage dip, fan movement or compressor vibration</b>	Low voltage at unit: C/o=9.6V C/in=11.0V	Charge battery	
1		Excessive voltage drop from battery to unit during start-up attempt	Correct wiring (refer to manual)	
3,4		Internal refrigerant pressures not yet equalized	Shut off power, wait 15 minutes, restore power	
		Faulty electronic module	Replace electronic module	
3		Faulty compressor	Call factory	
5		Excessively hot electronic module	Improve air flow to unit	
4,5		Overheated compressor	Improve air flow to unit	
2		<b>Compressor does not run, fan does not run</b>	Defective or shorted relay or wiring drawing over 0.5 amps activates protective circuit in electronic module	Replace PCB inside stainless steel electrical box
			Fan / Pump fuse blows	Replace fuse (5 amp)
	Faulty fan		Replace fan	
	Faulty wiring to fan		Repair wiring fault	
	Fan okay, but module faulty test by putting 12V to fan directly		Replace electronic module	
	<b>Intermittent compressor/fan operation</b>	Poor electrical supply, chronic voltage fluctuations	Review manual, correct wiring faults, recharge or replace battery	
		Faulty control module	Replace control module	
		Faulty compressor	Call WAECO USA (860.664-4911)	
	<b>Power duct fan does not run</b>	Faulty fan (test with 12V DC power source)	Replace fan	
		Faulty wiring to power duct fan	Repair wiring	

# TROUBLESHOOTING

LED BLINK CODE	SYMPTOM	TEST / DIAGNOSIS	CORRECTIVE ACTION
	<b>Compressor and fan cycle but box not cold enough</b>	Digital thermostat control setting too warm or control is defective	Re-program digital control, lowering set point (SP) and "HI" and "LO" settings (see manual) or replace control
		Analog thermostat set too warm or defective	Adjust control or replace
		Evaporator too small for box	Call WAECO USA (860.664-4911)
		Thermostat tube touching evaporator	See manual, correct
	<b>Compressor and fan runs, evaporator frosts, but box not cold enough</b>	Inadequate air flow to condensing unit	Remove blockage and/or improve circulation
		Refrigerant undercharge-only part of the evaporator is frosting*	Call WAECO USA (860.664-4911)
		Refrigerant overcharge-evaporator is fully frosted plus frost continues along tube set beyond rubber insulating sleeve	Call WAECO USA (860.664-4911)
		Partial clog in refrigerant circuit only part of the evaporator is frosting	Call WAECO USA (860.664-4911)
3		Box insulation is inadequate or box too large	Re-insulate. Contact local dealer for assistance. Find local dealer online: <a href="http://www.waecousa.com">www.waecousa.com</a>
3,4,5		Condensing unit in very hot area and/or condenser fins blocked	Relocate unit, remove blockage provide better airflow, review Duct Kit section of this manual
		Thermostat tube touching evaporator	See manual, correct
	<b>Compressor and fan run continuously, no cooling at all</b>	No refrigerant in system: Loose couplings, defective component(s) punctured evaporator, broken tubing. "Hiss" may be audible at evaporator when compressor is running	Call WAECO USA first. Decision to repair locally or return entire system (evaporator & condensing unit) to factory will be made before proceeding.
		Complete clog inside refrigerant circuit: no audible "hiss" at evaporator while compressor is running	Call WAECO USA for assistance in confirming this diagnosis and best way to proceed

**\*NOTE: FEDERAL LAW PROHIBITS SERVICING OF THIS REFRIGERANT CIRCUIT BY NON-CERTIFIED OPERATORS. PLEASE CALL WAECO USA'S TECHNICAL SERVICE DEPARTMENT FOR ASSISTANCE.**

# TROUBLESHOOTING

LED BLINK CODE	SYMPTOM	TEST / DIAGNOSIS	CORRECTIVE ACTION
	<b>Compressor and fan run continuously, food in refrigerator freezes</b>	Thermostat control set too cold	Turn knob (analog) to lower number, and if digital re-program
		Thermostat shorted, defective or malfunctioning	Call WAECO USA (860.664-4911)
		Box very small or unusually well insulated	Install partition between evaporator and perishable food section
		Thermostat sensing bulb not mounted correctly	See manual, correct
	<b>Water pump runs, no water flow</b>	Air in pump, cannot self-purge	Check piping for leaks, air entry re-prime pump, re-pipe (see instructions)
		Impeller spindle damaged from dry running	Obtain service parts from factory
		Obstructions in inlet pipe, strainer, or outlet piping	Locate and eliminate
	<b>Water pump motor does not run, does not pump</b>	Blown FAN/PUMP fuse on condensing unit	replace with 5 amp fuse
		Defective wiring	Locate and repair
		Defective pump	replace entire pump
		Foreign material jammed pump impeller	Disassemble and remove

## PROCEDURE FOR REMOVING COMPRESSOR UNIT

1. Turn off DC power supply breaker for unit.
2. Disconnect the mating plugs of the thermostat control wire harness approximately one foot from compressor unit.
3. Remove both DC power supply wires from the upper (-) and (+) screws of the terminal strip module.
4. Shut inlet seacock (if water cool option is installed). Remove the 2 hoses from the condensing unit.
5. Disconnect the mating plugs of the digital or analog thermostat located on the condensing unit.
6. The refrigerant in this system must first be extracted by a qualified technician using approved recovery equipment before the couplings can be loosened or disconnected.
7. Disconnect both refrigerant couplings. Use two open-end wrenches: 13/16" hex or 10" adjustable to **turn the female coupling**. 5/8" hex or 10" adjustable to **hold the male coupling**.
8. Turn only the female coupling. Do not turn the male coupling. If you twist the coupling from its soldered tubing connection, you will have a refrigerant leak. This is why you must use two wrenches.
9. Remove the compressor unit from the boat. Handle carefully. Do not pick it up by the tubing or electronic module. Be careful not to cut your fingers on the cooling fins and do not bend them (The fins are soft and thin for maximum efficiency).

## PROCEDURE FOR REMOVING EVAPORATOR AND TUBE SET

1. Turn the thermostatic control to OFF.
2. Disconnect the 12V DC power supply to the compressor unit. Carefully remove the sensing tube of the thermostatic control from its clamp on the side of the freezer by loosening two screws and sliding out the "U" bend section of the tube.
3. Disconnect both pairs of refrigerant couplings at the compressor unit (see item 4 of the "Procedure for Removing Compressor Unit.")
4. Remove the soft mastic caulking material from the exit hole into the icebox where the tubing and wire harness pass through.
5. Using a "stubby" screwdriver, unscrew the four mounting screws (save these) and carefully withdraw the entire freezer and its 15 foot tube set from the icebox.
6. Be careful not to kink or flatten the tubing. Screw the plastic sealing caps into the coupling to keep them clean.
7. Carefully roll up the entire coil by rolling it around a cylindrical object of about 18" diameter.

## PROCEDURE FOR REMOVING POWERPLATE AND TUBESSET

1. Defrost the PowerPlate and thoroughly dry the small couplings.
2. Disconnect the 12V DC power supply to the condensing unit.
3. Disconnect the couplings at the PowerPlate, using correct wrenches and taking care not to turn the soldered-in bases.
4. Install the plastic caps to protect the coupling.
5. Remove the PowerPlate by extracting the mounting screws and plastic standoffs.
6. Remove the tubeset, first removing the soft self-sealing mastic at the box exit.
7. Coil the tubeset carefully around a 12" diameter cylindrical object.

## IMPORTANT INFORMATION

### WAECO USA LIMITED WARRANTY

WAECO USA, Inc. warrants its products to be free of defects in materials and workmanship for the periods specified below subject to the specified conditions and limitations. *What WAECO Will Do:* Repair or replace (choice of remedy at Company's discretion) goods or parts that prove to be defective in materials or workmanship after examination by a factory representative or authorized service dealer.

### How long Coverage Lasts: COMPRESSOR PRODUCTS

*Labor:* WAECO will pay for necessary labor from an authorized service agent for one year from date of purchase or third party installation. For OEM factory installed products the duration is one year from the date of purchase of the vehicle (vessel).

*Parts:* WAECO will pay for necessary parts for two years from the date of purchase or third party installation. For OEM factory installed products the duration is two years from the date of purchase of the vehicle (vessel).

### What is Not Covered:

1. Damages due to accident, misuse, abuse, normal wear, improper installation, lack of reasonable and necessary maintenance, transportation, corrosion, tampering, improper repair, unusual physical or electrical stress or recharging of the coolant.
2. Electric light bulbs or replaceable fuses.
3. Failures due to use of the products in applications for which they are not intended.
4. Warranty coverage following unauthorized service.
5. Warranty coverage following transfer of ownership.

### How State Law Relates to this Warranty:

This warranty gives you specific legal rights, and you also have other rights, which vary from State to State.

THERE ARE NO OTHER WARRANTIES OF MERCHANTABILITY, FITNESS FOR PURPOSE OR ANY OTHER KIND. ANY EXPRESSED OR IMPLIED ARE HEREBY DISCLAIMED AND EXCLUDED. THE COMPANY SHALL NOT BE LIABLE FOR CONSEQUENTIAL DAMAGES TO YACHTS, EQUIPMENT OR OTHER PROPERTY OR PERSONS DUE TO ANY FAILURE OF WAECO USA PRODUCTS. THIS WARRANTY IS EXPRESSLY PROVIDED IN LIEU OF ALL OTHER WARRANTIES EITHER EXPRESSED OR IMPLIED.

Should your new WAECO USA or ADLER/BARBOUR product not perform properly, please refer to the trouble shooting section of your owner's manual first.

If the problem persists, please have the following information available before placing a call to us:

PRODUCT SERIAL NUMBER

DATE OF PURCHASE

LOCATION OF PURCHASE (DEALER)

Call WAECO USA's Customer Care Department @ (860) 664-4911 Monday – Friday 8:00am to 5:00pm EST.

Please do not return to place of purchase. Call us, it may be something that was simply overlooked and could easily be resolved over the telephone.

### RETURN POLICY

Returned products, parts and assemblies are subject to the following terms and conditions:

1. A **Return Merchandise Authorization** number (RMA) must be issued PRIOR to the item(s) being returned for credit or repair.
  2. RMA's will be issued prior to the return. When requesting a RMA number, the following information must be furnished:
    - Your name or company name, address and telephone number.
    - Items (part numbers) being returned.
    - Reason for return.
    - If possible, supply the WAECO USA order or invoice number on which the product was shipped.
  3. All returns must be sent post paid to:  
WAECO USA, INC  
Attention: Service Department  
RMA#  
8 Heritage Park Road  
Clinton, CT 06413
- \* The RMA number MUST be printed on the exterior carton.

ALL PRODUCTS BEING RETURNED FOR CREDIT ARE SUBJECT TO A 15% RESTOCKING FEE. ALL RMA numbers are valid for 30 days from issue date.

# **WAECO**

## **mobile solutions**

### **WAECO USA, Inc.**

P.O. Box #497

8 Heritage Park Road

Clinton, CT 06413

Tel. (860) 664-4911 • Fax. (860) 664-4912

[www.waecousa.com](http://www.waecousa.com)