

PRM DELTA MARINE GEARBOX



WORKSHOP MANUAL

- **NEWAGE TRANSMISSIONS LIMITED**

- Barlow Road

- Coventry CV2 2LD

- England

- Telephone: (01203) 617141

- Fax: (01203) 611845



FOREWORD

Provided it is correctly installed, aligned and maintained, the PRM DELTA gearbox should have a long and trouble-free life. This workshop manual contains important instructions to ensure that this is so, and it is of the utmost importance that these are carefully followed. Newage Transmissions can accept no responsibility under warranty or otherwise for any loss or damage resulting from failure to observe these instructions.

To avoid prejudging your rights under warranty, do not undertake any repair or other work on the gearbox during the warranty period without first contacting Newage Transmissions or an authorised distributor or dealer for advise. In the event of failure, you should do this via the engine distributor who supplied the gearbox, or his local dealer; if this is not possible, you should notify the local Newage distributor/dealer or Newage Transmissions direct.

CLAIMS UNDER WARRANTY

Claims for replacement of parts under warranty must always be submitted to the distributor who supplied the gearbox; if this is not possible, application may be made to the nearest distributor or dealer, who must, however, be advised of the supplier's name and address.

SERVICE PARTS

The comprehensive illustrated parts list gives full information and ordering procedure.

PRE-DELIVERY TEST

Before it leaves the factory, every gearbox is subjected to a final test and inspection which includes the following:-

1. Flush clean.
2. Check time to reach operating temperature.
3. Pressurise case, check for leaks.
4. Check noise levels.
5. Check for drag in neutral.
6. Check valve lever operating force.
 - 6A Neutral to forward.
 - 6B Neutral to reverse.
7. Check operating temperature.
8. Check operating oil pressure at 2000 rev/min.
9. Check output nut torque.
10. Check input spline dimensions.
11. Check bolt torques.
12. Check coupling concentricity.
13. Check for conformity with details on serial number plate.

IDENTIFICATION PLATE

Every PRM gearbox is fitted with an identification plate on the top half of the gearcase before it leaves the factory; an example of such a plate is shown below.

NEWAGE	PRM	COVENTRY
123456		R1234
DELTA 30		
MADE IN ENGLAND		

NEWAGE	PRM	COVENTRY
MADE IN ENGLAND		

Please complete the above box with serial number and specification of your own gearbox.

It will be noted that there are two lines of numbers.

The top line is the gearbox serial number, and should always be quoted when ordering spare parts; this enables the factory to trace the history of the gearbox right back to its date of manufacture and the components and materials used in its production, thus ensuring that the correct components can be supplied as replacement parts.

The lower line is the gearbox specification; in the example given this translates as follows:-

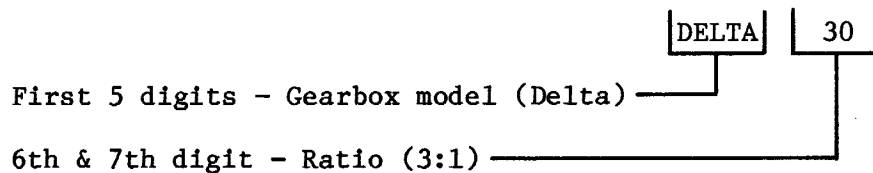

CONTENTS**Page**

1.	GENERAL DATA	6
	1.1 Specifications	
	1.2 Applications data	
	1.3 Installation details	
2.	INTRODUCTION	9
3.	CONSTRUCTION	9
	3.1 Gearcase	
	3.2 Gear train	
	3.3 Oil pump	
	3.4 Valve block	
	3.5 Neutral safety switch	
4.	OPERATING SYSTEM	11
	4.1 Output rotations	
	4.2 Hydraulic system	
	4.3 Lubrication	
	4.4 Approved oils	
5.	INSTALLATION	14
	5.1 General	
	5.2 Checking the flywheel housing	
	5.3 Checking the flywheel	
	5.4 Mounting the gearbox to the engine	
	5.5 Oil cooler	
	5.6 Alignment to propeller shaft	
	5.7 Installation angle	
	5.8 Twin installations	
	5.9 Remote control operating unit	
6.	OPERATION	19
	6.1 First-time usage	
	6.2 Drive selection	
	6.3 Trailing (free-wheeling) the propeller	
	6.4 Emergency operation	
7.	ROUTINE MAINTENANCE	21
	7.1 Initial maintenance (25 hours running)	
	7.2 Daily checks	
	7.3 Annual checks	
	7.4 Winter storage	
	7.5 Other maintenance operations	

	Page
8. FAULT FINDING	21
9. SERVICING AND REPAIRS	22
9.1 Valve block	
9.2 Oil pump	
9.3 Removing transmission from boat	
9.4 Removing input and layshaft assemblies	
9.5 Servicing input and layshaft assembly components.	
9.5.1 Input shaft oil seal	
9.5.2 Drive end bearing	
9.5.3 Clutch assembly	
9.5.4 Clutch gear	
9.5.5 Drive pinion	
9.5.6 Non drive end bearing	
9.5.7 Piston rings and feeder	
9.6 Replacing the input and layshaft assemblies	
9.7 Servicing output shaft assembly	
9.7.1 Front bearing and output gear	
9.7.2 Rear bearing and oil seal	
9.7.3 Re-assembling output shaft assembly	
10. TIGHTENING TORQUES	31
11. REPLACEMENT PARTS LIST	32

LIST OF ILLUSTRATIONS

Page

Fig. 1	PRM DELTA - Exploded view	5
Fig. 2	Installation drawing	8
Fig. 3	Internal layout	10
Fig. 4	Wiring diagram for Neutral safety switch	11
Fig. 5	Hydraulic and lubricating oil circuits	12
Fig. 6	Checking trueness of flywheel and flywheel housing	15
Fig. 7	Engine and gearbox cooling circuit	16
Fig. 8	Oil cooler connections PRM Delta	16
Fig. 9	Propeller rotation, twin installations	18
Fig. 10	Operating lever movement for ahead drive, twin installations	18
Fig. 11	Removal of bolts for emergency operation	20

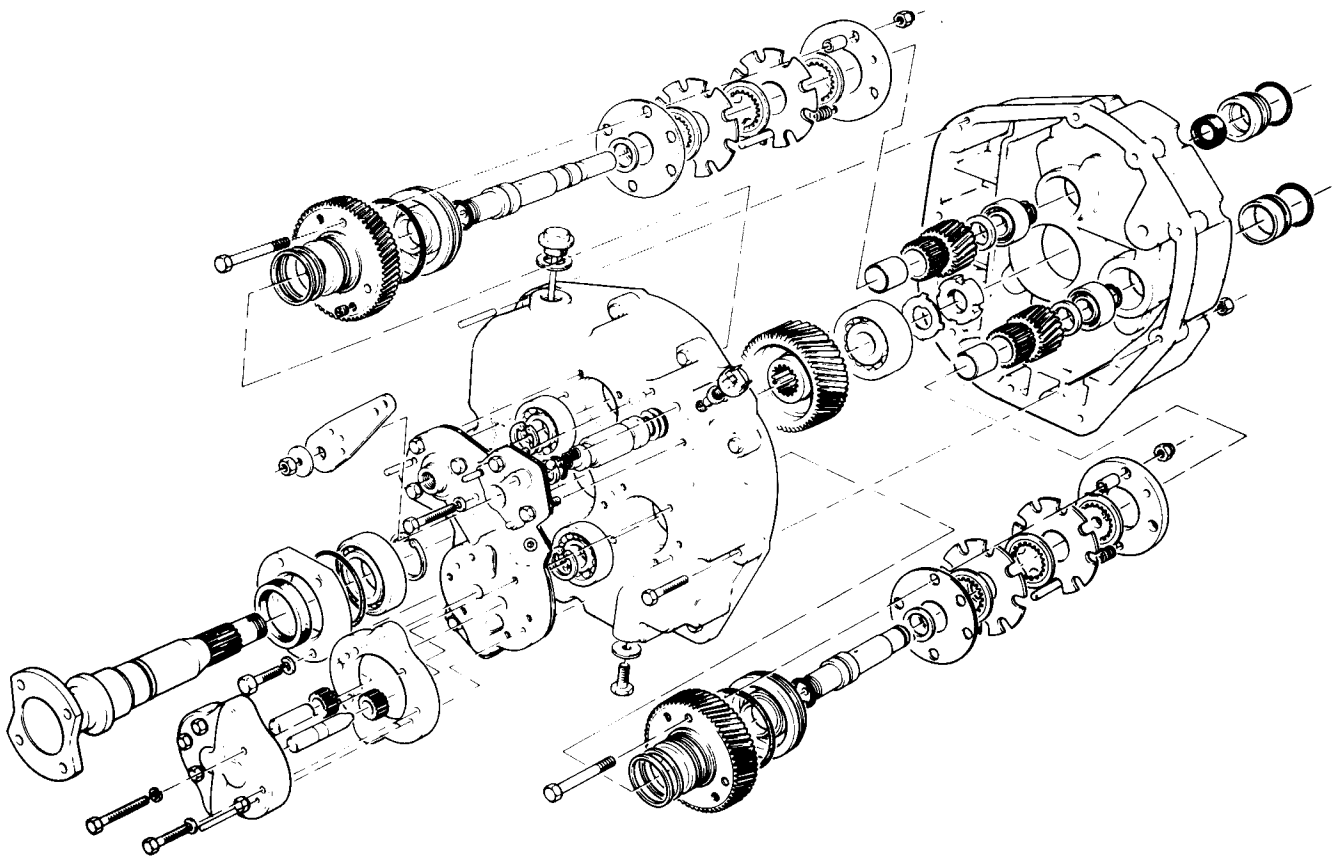

Fig. 1 PRM Delta Exploded View

1. GENERAL DATA

1.1 Specifications

Gear ratios

1.53:1, 2.09:1, 2.83:1.

Power rating:

Up to 2.1hp (1.6kW) per 100 rev/min (pleasure boats)

Up to 1.5hp (1.1kW) per 100 rev/min (commercial)

Note: All ratings are for guidance and will vary according to application and duty cycle. Further details available from Newage Transmissions plc. or local distributor.

Input speed:

Up to 3600 rev/min continuous

4000 rev/min intermittent

Input rotation:

For engines of left-hand (anti-clockwise) rotation as viewed looking on the flywheel from behind the engine.

Output rotation:

Either hand.

Approximate dry weight:

21 Kg (46 lb)

(excluding drive coupling, adaptor flange and oil cooler).

Oil capacity:

1.4 litres (2.5 pints)

Note: above capacities do not include oil required to fill the cooling circuit.

Operating pressure:

Minimum:- 2310kPa (335 lb/in²).

Maximum:- 2895kPa (420 lb/in²).

Note: Pressure may vary at different operating speeds; it is likely that, on start up, when the gearbox is cold, significantly higher pressures may occur.

Working oil temperature:

The normal operating temperature of the oil should be in the 50°C - 70°C range and should not be permitted to exceed 80°C.

Transmission cooling:

An oil cooler is necessary to ensure that correct operating temperatures are maintained and the gearbox is provided with two 1/4 inch BSP connectors to allow it to be fitted. The size of the cooler depends on a number of factors including the transmissions horse power, operating speed, duty cycle, inlet temperature and ambient temperature.

Suitable coolers are available from Newage Transmissions plc.

Engine mounting adaptors

Available in SAE3, SAE5, BW and special patterns.

Input drive couplings:

Spring centre damper plate SAE 6.5" or SAE 7.5".

Gearcase:

Made from heavy duty aluminium alloy for use in a marine environment and ribbed internally for strength and rigidity. Made in two halves to facilitate servicing.

Input shaft:

19mm (.75 in) diameter with 17 tooth spline, 24/48 DP, 45° pressure angle.

Propeller thrust:

Ahead and astern thrust carried by output shaft bearings of adequate capacity for all Newage approved ratings.

Output flange:

102mm (4 in) diameter, with 4 holes, 10mm (0.4 in) diameter on 82.5mm (3.25 in) PCD.

Installation angle:

The maximum fore and aft installation angle permissible at rest is 15°.

NOTE: These ratings have been established in order to ensure the long and trouble-free life of the gearbox. However, operating conditions can vary widely with consequential effects on the gearbox and these ratings should therefore be used for general guidance only. If in any doubt, or for particularly arduous duty, or for applications outside the powers and speeds shown here, please consult the factory or distributor.

Pleasure Boats

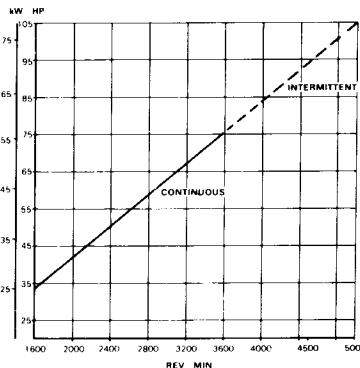

Work Boats

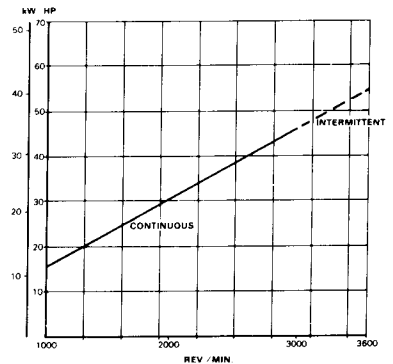

Rating Diagram

1.3 Installation details

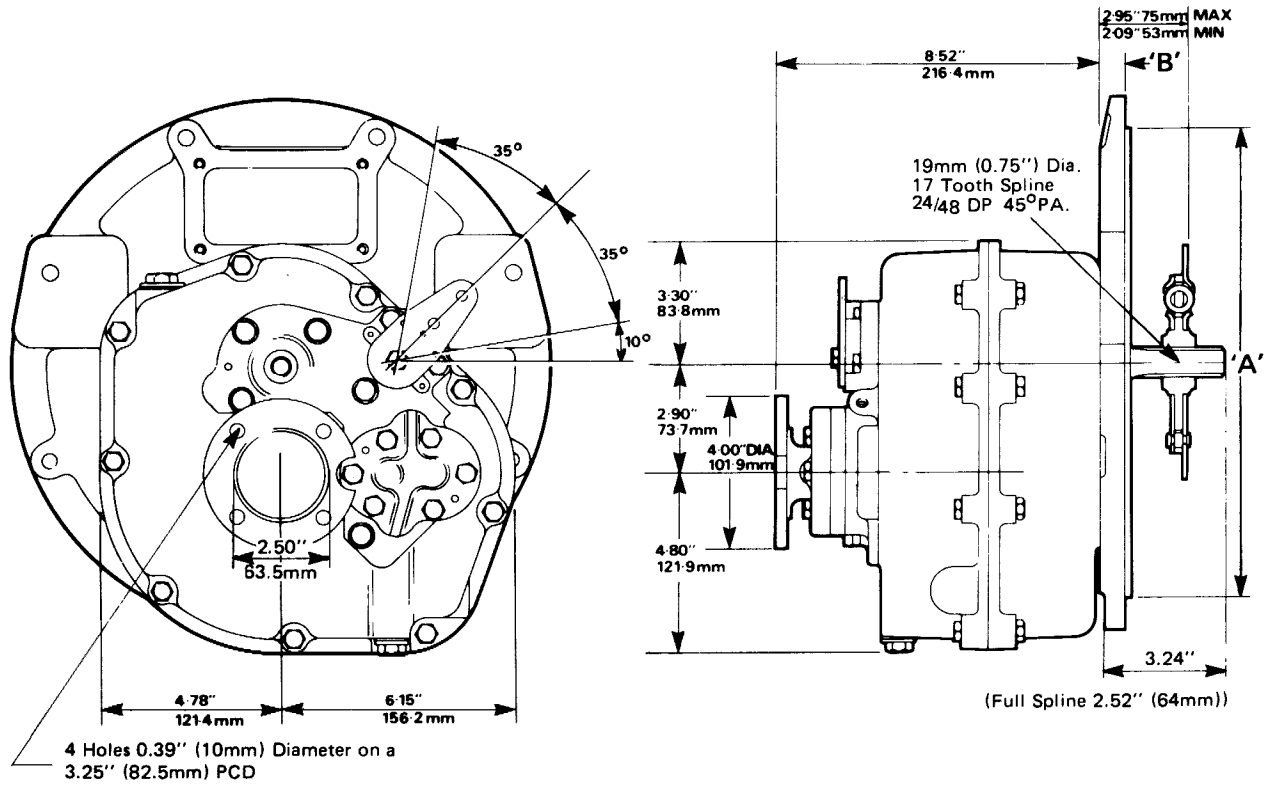

Adaptors	'A'		'B' (nominal)	
	mm	inches	mm	inches
SAE 5	314.3	12.37	16.0	0.63
B/W	209.5	8.25	20.25	0.80

Installation angle
 The maximum fore and aft installation angle permissible at rest is 15°.

Fig. 2 Installation drawing

2. INTRODUCTION

Newage PRM marine transmissions are oil-operated gearboxes of the counter-shaft type with separate oil-operated multi-disc clutches (which need no adjustment) for both ahead and astern drive. This design permits full power to be transmitted in astern as well as ahead, and also allows right-hand or left-hand propeller rotation in ahead drive, with identical ratios in ahead and astern.

Rotation for left-hand (anti-clockwise) engines only can be accommodated on the PRM Delta gearbox.

Note: when describing engine rotations, face the engine on which the transmission is to be mounted and describe the rotation accordingly. Similarly, describe the transmission output rotation as clockwise or anti-clockwise as seen when standing behind the gearbox output coupling facing towards the input or engine end of the transmission.

3. CONSTRUCTION

3.1 Gearcase

The gearcase has been kept free from hydraulic pipes, cylinders and associated components, and the only items mounted externally are the oil pump, oil cooler and operating lever.

A drain plug is provided at the rear of the gearcase; this can be removed if required to allow suitable pipework to be connected to a hand-operated drain pump.

Connections are provided on the valve block for the oil cooler and pressure gauge.

3.2 Gear train

The transmission comprises an input shaft assembly, a layshaft assembly and an output shaft.

The input shaft, which is supported by a roller bearing at either end, incorporates a drive pinion of the required ratio, the forward (when used with a right-hand propeller) drive clutch assembly, the clutch gear and a hydraulic actuated piston to operate the clutch.

The layshaft is similarly supported by roller bearings and also incorporates a drive pinion of the same ratio, the reverse (when used with a right-hand propeller) drive clutch assembly, a clutch gear of opposite hand rotation to that on the input shaft, and a hydraulically actuated piston to operate the clutch.

The output shaft runs on amply proportioned bearings, arranged in such a way that propeller thrust can be satisfactorily absorbed; it also carries the output gear and the output flange.

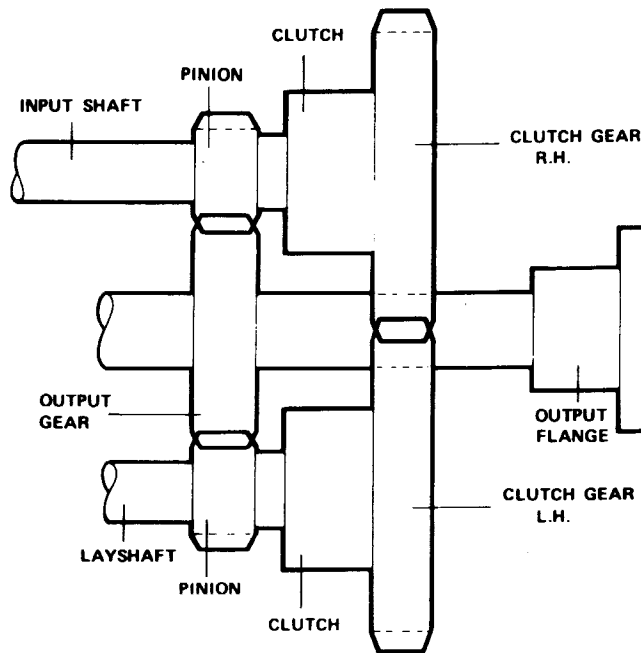

Fig. 3 Internal Layout

3.3 Oil pump

A cast iron gear-type pump externally mounted at the rear of the gearcase and normally driven by the layshaft, supplies oil at high pressure for actuation of the clutch assemblies, and at lower pressure for lubrication and it should be noted that pressure may vary at different operating speeds. It is also likely that, on start up, when the gearbox is cold, significantly higher pressure may occur.

3.4 Valve block

The valve block, located on the rear of the gearcase, contains the main control valve, which in turn incorporates the high pressure valve which controls oil supply to the clutch assemblies. Any oil surplus to clutch operation requirements is used for lubrication purposes.

The control valve is fitted with a spring-loaded neutral detent which provides a positive feel to the neutral position and ensures positive selection of either ahead or astern drive.

3.5 Neutral safety switch

A neutral safety start switch, which prevents the engine from being started unless the gearbox is in neutral, is available as an optional extra.

This device is of obvious benefit, since it will help prevent accident or damage caused by a boat moving ahead or astern on engine start-up in a crowded marina or other area. Newage Transmissions plc strongly recommends the use of this device.

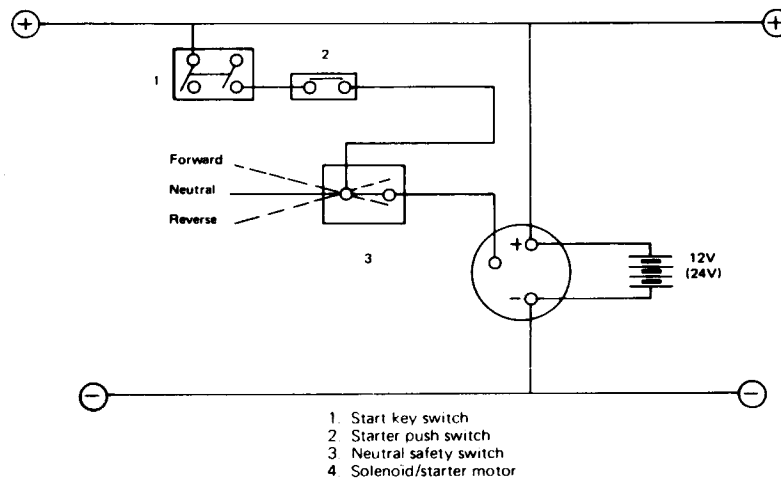

Fig. 4 Wiring diagram for neutral safety switch

When used, the switch is located on top of the rear gearcase half, immediately in front of the control lever, and should be wired into the starter circuit as shown in Fig. 4.

4. OPERATING SYSTEM

4.1 Output rotations

With the control lever at the mid-point of travel or neutral position and the engine running, the splined input shaft and the clutch gear rotate at engine speed. The clutch gear is in constant mesh with the clutch gear on the layshaft which is therefore also driven at engine speed, but in the opposite rotation. Since neither clutch is engaged, the drive pinions do not rotate.

When the control lever is moved to the 'ahead' position the hydraulic system is actuated and oil is directed at high pressure to the clutch on the appropriate shaft; the clutch engages and engine drive is directed to the forward drive pinion. The pinion turns the gear on the output shaft and the propeller shaft and propeller are rotated in the direction corresponding to ahead movement of the vessel.

Similarly, when the control lever is moved to the 'astern' position, the clutch on the opposite shaft is engaged and drive applied to the reverse pinion. This turns the output shaft gear in the opposite direction; and the propeller shaft and propeller rotate in the direction corresponding to astern movement of the vessel.

4.2 Hydraulic system

Oil is pumped from the gearbox sump through the internal supply pipe and is delivered to the control block, which incorporates a high pressure valve to ensure that the correct operating pressure is maintained.

When the operating lever is moved, oil is delivered under pressure to either the input shaft or layshaft and thence to a piston which actuates the appropriate clutch for either ahead or astern drive.

Oil in excess of that required for hydraulic actuation is used for lubricating the gearbox.

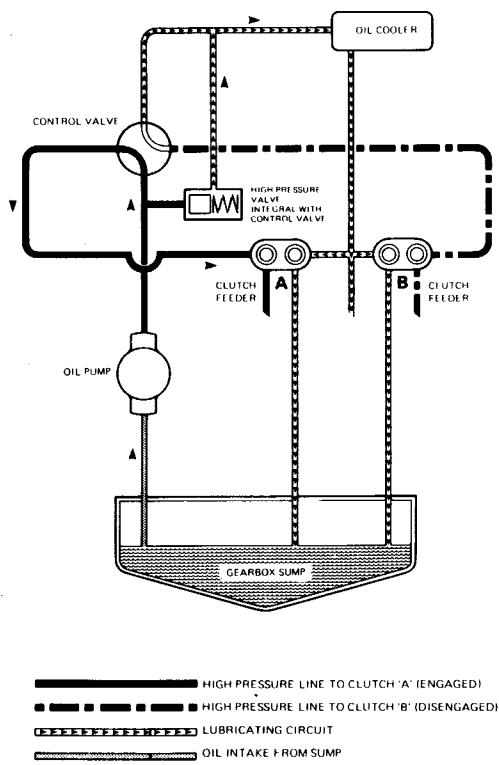

Fig. 5 Hydraulic and lubricating oil circuits

4.3 Lubrication

Oil for lubrication purposes is also delivered via the internal supply pipe to the control block. Irrespective of whether ahead or astern is engaged, oil is diverted from the discharge side of the pressure relief valve to an external oil cooler. After passing through the cooler, the oil is directed through channels on the valve block and thence through the layshaft and drive shaft to lubricate the clutch assemblies.

4.4 APPROVED OILS

Below Zero : 10W30 or 20W. Engine oil to AP1 designation CD.

0°C to 30°C : 10W30 or 30W. Engine oil to AP1 designation CD.

Above 30°C : 10W30 or 40W. Engine oil to AP1 designation CD.

It is essential that only **good quality** engine oil, supplied by a **recognised and well known manufacturer**, is used in Newage marine transmissions.

Failure to comply with the above oil types may result in the forfeiture of warranty cover since no claims under warranty will be entertained if oil of the wrong specification is used.

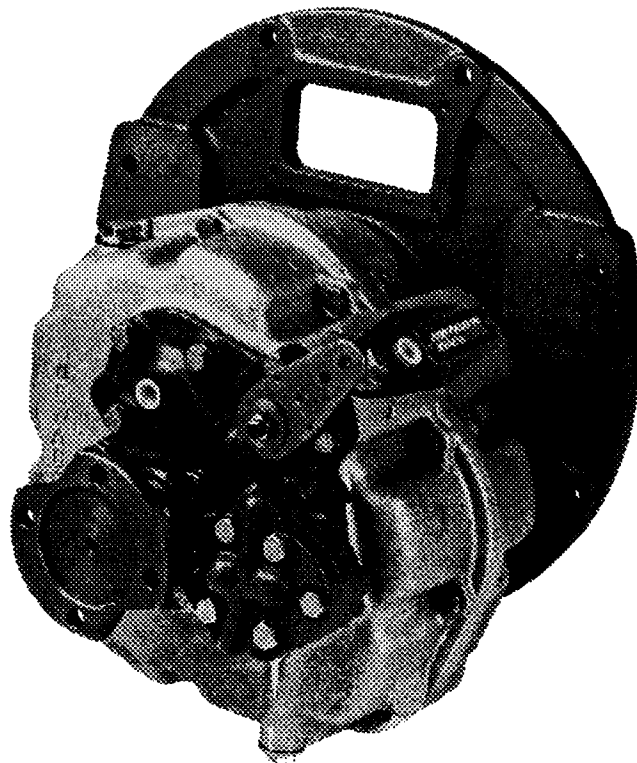

PRM DELTA MARINE GEARBOX BY NEWAGE

5. INSTALLATION

5.1 General

Drive is transmitted from the engine to the gearbox via a spring centre drive plate (damper plate) which bolts to the engine flywheel with the gearbox input shaft inserted into its centre.

These components enjoy a degree of torsional flexibility, the purpose of which is to damp down engine torsional or cyclic vibrations and prevent them being passed to the transmission.

The strongest engine vibrations are usually those caused by firing in the cylinders; diesel engines which have high compression ratios, usually generate stronger vibration pulses than petrol (gasolene) engines; and it is often the case that of two engines of roughly equivalent size, the one having the greater number of cylinders will tend to run more smoothly than the one with fewer cylinders, although this is by no means always the case.

In all marine installations, correct alignment is of the utmost importance - misalignment can cause noise, vibration and premature failure - and we strongly recommend that all the procedures detailed in this manual are carefully followed.

Note: It is particularly important to ensure the torsional compatibility of the complete propulsion system from engine through to propeller since disregarding this may result in gear noise at low speed operation and in extreme cases damage or failure of components.

Newage Transmissions plc. will provide all possible information and assistance to help find solutions to potential torsional problems, but it is the ultimate responsibility of the person assembling the drive and driven equipment to ensure that they are torsionally compatible.

5.2 Checking the engine flywheel housing

Attach a dial test indicator, calibrated in units of 0.001 in. (0.025mm) or smaller, to the flywheel so that the measuring stylus of the indicator is perpendicular to the bore of the flywheel housing (bore A on Fig. 6). Rotate the flywheel and check the deviation on the indicator over one complete revolution: this should not exceed 0.006 in. (0.152mm) total indicator reading.

With the dial test indicator still attached to the flywheel, re-position the stylus so that it is perpendicular to the face of the flywheel housing (face B on Fig. 6). Rotate the flywheel and check the deviation over one complete revolution; again, this should not exceed 0.006 in. (0.152mm) total indicator reading.

5.3 Checking the engine flywheel

Attach a dial test indicator, calibrated to 0.001 in (0.025 mm) or less, to the engine flywheel housing so that the measuring stylus of the indicator is perpendicular to the bore of the register in the flywheel (bore C on Fig 6). Rotate the flywheel through one complete revolution and note the deviation, this should not exceed 0.005 in (0.125mm) total indicator reading.

With the dial test indicator still attached to the flywheel housing, reposition the stylus so that it is perpendicular to the face of the flywheel register (D on Fig 6). Rotate the flywheel through one complete revolution and note the deviation, this should not exceed 0.005 (0.125mm) total indicator reading.

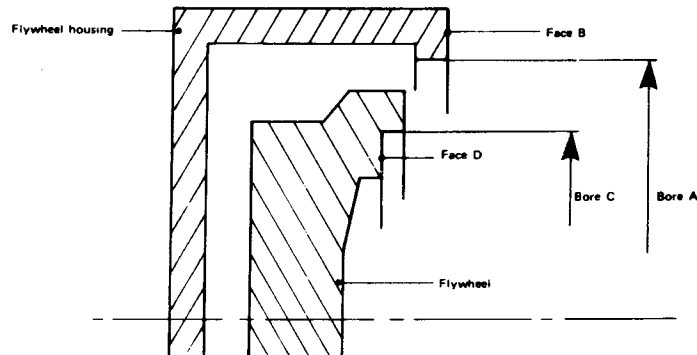

Fig. 6 Checking trueness of flywheel and flywheel housing

5.4 Mounting the gearbox to the engine

1. Ensure that the Redcap plastic seal covering the output shaft bearing is removed.
2. Ensure that the recess in the adaptor plate is of sufficient depth to accommodate the end of the output shaft bearing.
3. Fit 'O' ring to adaptor plate groove and fit adaptor plate to the gearbox, tightening to a torque of 30Nm (22 lbf.ft.)
4. Mount the drive plate to the flywheel, using an alignment mandrel if available, and bolt to the flywheel. Where components to SAE standard are used, the outside diameter of the drive plate should be a close fit in the register on the flywheel.

If a mandrel is not available, tighten the bolts just sufficiently to prevent free movement, assemble the gearbox to the drive plate and rotate the engine two or three revolutions by hand to align the plate.

Tighten up two or three opposite bolts. Remove the gearbox and fully tighten all the drive plate bolts.

5. Offer the gearbox and adaptor to the drive plate and flywheel housing. Insert the gearbox input shaft into the centre of the drive plate (it may be necessary to rock the shaft slightly to ensure the shaft enters). Press the assembly fully into position, align the holes in the adaptor with those on the flywheel housing and tighten fully.

5.5 Oil cooler

All Newage PRM Delta gearboxes must be fitted with an oil cooler to maintain correct working temperatures. To permit a suitable cooler to be fitted, two $\frac{1}{4}$ in. BSP connections are provided on the valve block, and these are blanked off with "Redcap" seals on delivery from the factory.

The gearbox oil cooler is normally mounted on the gearbox adaptor flange or the bulkhead of the boat, and then connected into the cooling system on the engine; one method of arranging the engine and gearbox cooling circuit is shown below.

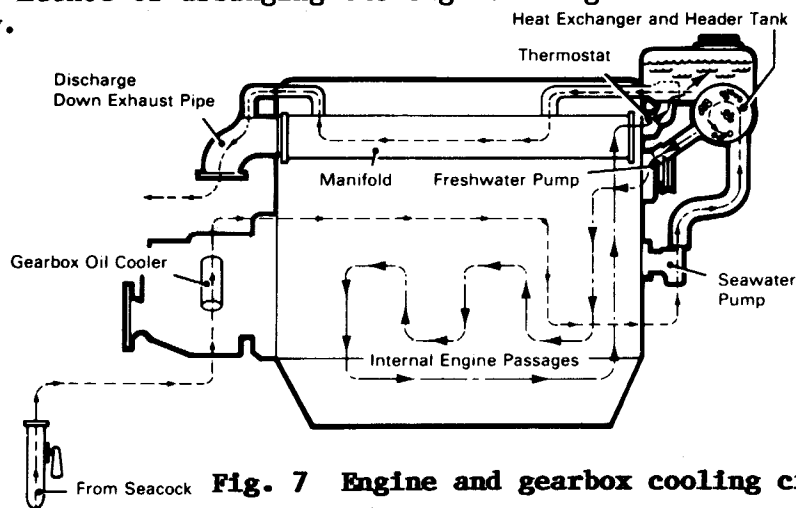
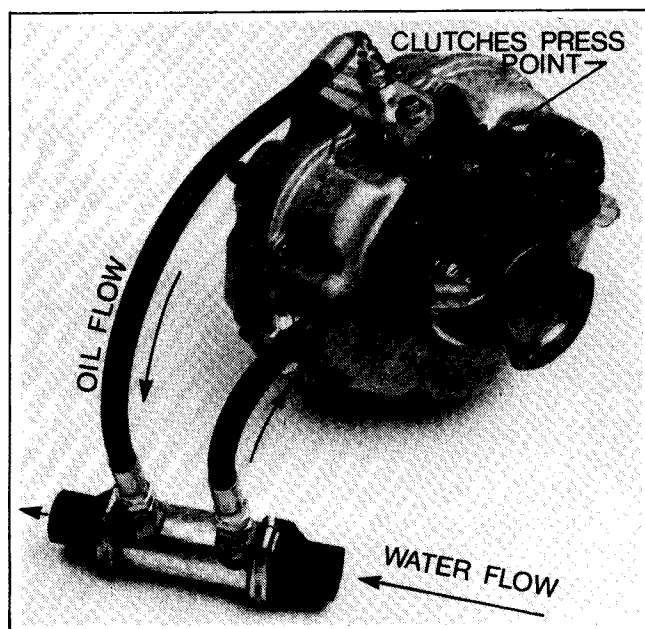

Fig. 7 Engine and gearbox cooling circuit

Remove the "Redcap" seals from the valve block and connect, via suitable hoses, to inlet connections on the oil cooler, which can then be incorporated into the engine cooling system as outlined above.

Note: Operating oil temperature should not exceed 80°C under any circumstances. If the checks listed in the fault-finding chart have been carried out without any fault being found and the gearbox consistently runs at a temperature higher than 70°C, Newage strongly recommends that a larger capacity oil cooler be fitted.

Fig. 8 Oil cooler connections



5.6 Alignment to propeller shaft

Alignment between the propeller shaft and the mating flange on the gearbox output shaft is extremely important since excessive vibration and stress leading to damage and perhaps even failure can occur if correct alignment is not achieved.

It is generally considered preferable to couple the propeller shaft direct to the gearbox output flange using a rigid coupling particularly in the majority of boats whose hulls have sufficient rigidity as not to allow flexing in heavy sea conditions, which could cause the engine and transmission to shift in relation to the propeller shaft.

The two main conditions when a flexible coupling should be used are:

- a) in boats whose hulls are not sufficiently rigid to prevent the flexing referred to above, and
- b) in cases where the engine is mounted on flexible mounts.

In both instances, the flexible coupling will isolate engine vibration or other movement from the propeller shaft and the stern tube to be maintained.

Whether a solid or flexible coupling is used, it is extremely important that the following points are carefully checked:

- i) the coupling should be a tight press fit on the shaft and the keyway accurately made to the correct size, and
- ii) the two halves of the coupling should be carefully aligned. This should be done by bringing the two flanges close enough together so that a feeler gauge can be used to check the vertical and horizontal alignment.

Since the propeller shaft line is normally fixed in the boat, alignment is usually obtained by adjusting engine mount shims on the mounts themselves.

Note: Whenever possible, the engine and gearbox should be installed whilst the hull is afloat, otherwise there is a danger of the hull distorting because of insufficient support over its surface. If the engine and transmission are fitted before the hull is in water, the installation should be very carefully re-checked for alignment after launching.

In designing PRM Delta, SAE standards were adhered to as far as possible. However, other manufacturers of similar sized transmissions have a different, but common, output coupling spigot, which is not to SAE. This spigot size has become the industry standard and most proprietary flexible output couplings are made to suit. Therefore, on some early Delta's an adaptor plate, sandwiched between the gearbox output coupling, was provided by Newage. This added approximately 6.4mm (0.25 in.) to the overall length of the gearbox. It should be noted that this applies to early Delta's only, as the output coupling spigot was modified to the industry standard as soon as was possible, thus eliminating the need for an adaptor.

5.7 Installation angle

The transmissions should normally be installed so that the maximum fore and aft angle relative to the water line does not exceed 15° with the boat at rest. Please consult Newage Transmissions if installation angles greater than this are required.

5.8 Twin installation

The rotation of a propeller, even in a single engine installation, tends to have a slight "turning" effect on the handling of the boat, but this can normally be corrected with very slight adjustments on the rudder.

In twin installations, the turning effect on the handling of the boat will be much more pronounced if both propellers rotate in the same direction. It is therefore desirable that "handed" (i.e. counter-rotating) propellers be fitted, and it is for this reason that PRM gearboxes are capable of providing either hand of output rotation at any of the available gear ratios.

It is also preferable for the starboard (right-hand) propeller to rotate clockwise and the port (left-hand) anti-clockwise rather than the other way about since in the latter case, when the propeller blades are at the lowest point of their rotational arc they tend to create a vacuum which affects the other propeller by reducing the flow of water to it; furthermore, when the boat is making a tight turn with one gearbox in "ahead" and the other in "astern", the thrust side of one propeller will be acting diametrically opposite to the other one, causing the boat to be deflected off line and thus delaying completion of the manoeuvre.

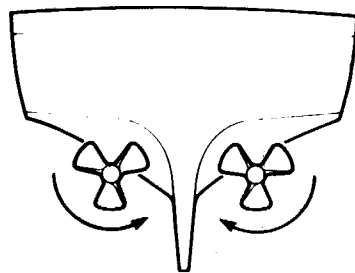

NORMAL APPLICATIONS

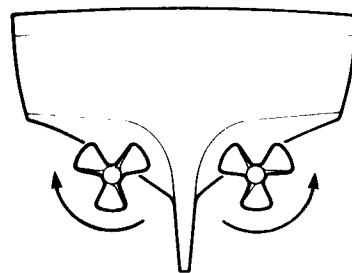

SPECIAL APPLICATIONS

Fig. 9 Propellor rotation twin installations

Moving the gearbox operating lever to the right will provide left-hand (anti-clockwise) propeller shaft rotation, moving it to the left gives right-hand (clockwise) rotation, as seen looking forward from propeller to gearbox. Either rotation can be used for ahead drive according to propeller fitted.

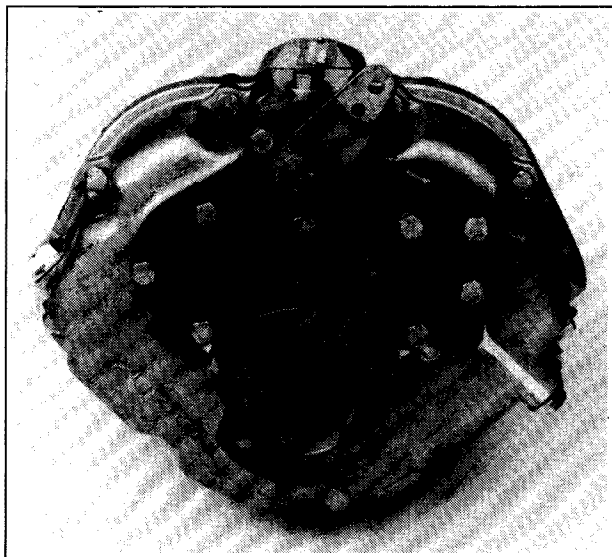

**PORT ENGINE
LEVER RIGHT
LH PROPELLOR ROTATION**

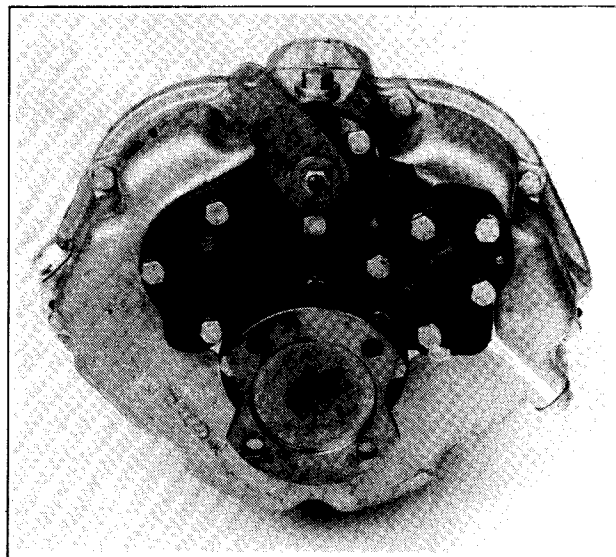

**STARBOARD ENGINE
LEVER LEFT
RH PROPELLOR ROTATION**

Fig. 10 Operating lever movement for ahead drive, twin installations

5.9 Remote control operating systems

All PRM gearboxes can be used with remote control operating systems and indeed the use of the single lever type of remote control, which links the engine throttle to the gearbox operating lever, is highly recommended.

The following points should be noted:

- (i) The gearbox operating lever is provided with a positive neutral position, which greatly assists the setting up of the remote control unit.
- (ii) care should be taken to ensure that the cable moves the gearbox operating lever approximately 1/16" (2mm) short of its maximum forward or backward travel to prevent the lever being brought hard up against the end stop with every gear shift.

6. OPERATION

6.1 First time usage

Before starting the engine fill the gearbox to the correct level with a suitable oil (refer to recommended list, section 4.4).

Ensure the gearbox is in neutral, (it is recommended that the optional neutral safety switch be wired into the starter circuit to avoid uncontrolled boat movement on start up.) Start and run the engine for a short time so that the oil circulates through the cooling circuit. Stop the engine and allow the oil to settle, re-check the level and top up to the maximum mark on the dipstick.

6.2 Drive selection

The Newage PRM Delta has been designed and tested to ensure rapid shifts from ahead to astern or vice versa and can be operated at full horsepower, ratings and speeds, and the transmission will respond rapidly in these circumstances.

Full power reversals, however, do place abnormal, even if short-lived, loads on the gearbox, and operating life will be prolonged if full power reversals are reserved for emergency use only.

Newage recommend that when changing direction the engine speed be brought down to approximately 1000 rev/min. For this reason we also recommend the fitment of a proprietary single lever remote control operating system which links the engine throttle control to the gearbox operating lever.

6.3 Trailing (free-wheeling) the propeller

The bearings used in the Newage PRM Delta gearbox have been carefully selected to ensure that prolonged trailing (free-wheeling) of the propeller will not have any detrimental effect on the transmission. This allows the propeller to turn freely with the engine shut down and makes the Newage PRM Delta particularly suited for use in auxiliary sailboats, motor sailers or multi-engine installations where the boat may be operated with one or more engines shut down.

It is not therefore necessary to provide any propeller shaft locking device to protect the transmission, although in the case of sailing yachts and other high performance sailboats fitted with two bladed propellers, it may be desirable to fit a propshaft lock so that the propeller can be locked behind the dead-wood to reduce drag.

Where propellers are allowed to free-wheel they can be a useful source of free auxiliary power; if a flat pulley is fitted to the propeller shaft a small generator can be belt driven for charging batteries (although care must be taken not to apply excessive side-load which would cause vibration and misalignment).

6.4 Emergency operation

Included as standard in every Newage PRM Delta gearbox is a "Get You Home" device allowing the gearbox to be mechanically locked in 'ahead' drive in the unlikely event of hydraulic clutch failure.

The method of operation is as follows:

1. Undo the 9 hexagon bolts securing the rear manifold to the gearcase and, taking care not to lose the small socket wrench which is located inside it, remove the manifold complete with oil pump. (See Fig. 11).
2. Rotate the input shaft until two socket screws in the clutch gear align with two holes in the rear of the gearcase.
3. Insert socket wrench through the holes in the gearcase and tighten the two screws; this locks the clutch plates together and provides drive for a right hand rotation propeller.
4. Reposition rear manifold and secure.
5. Ensure that sufficient oil remains in the gearbox to prevent further damage.
6. Select neutral on the operating lever and disconnect operating cable; the engine can now be run.

When the mechanical lock-up device is engaged it is important to remember:

- a) right hand propeller rotation only is available
- b) when emergency drive is in operation, astern or neutral cannot be engaged and there is no means of stopping the boat using the gearbox.
- c) the engine should not be run above $\frac{1}{3}$ full throttle.
- d) after emergency drive has been used, qualified assistance should be sought to give the transmission a thorough check before it is used again.

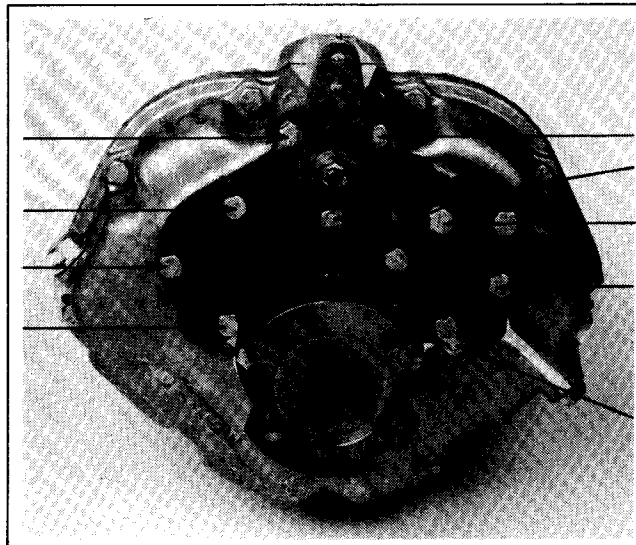

Fig. 11 Removal of bolts for emergency operation

7. ROUTINE MAINTENANCE

7.1. Initial maintenance (after 25 hours running)

Drain all oil from the gearbox and refill with one of the recommended lubricants. Operate the engine and gearbox, allowing the oil to circulate, then stop the engine and allow to settle. Re-check the oil level and top up if necessary to the maximum mark on the dipstick.

7.2 Daily check

1. Check the gearbox oil level
2. Make visual inspection of the general condition of the transmission and check for oil leaks, especially at the output shaft seal and at gasket sealing surfaces.
3. Listen for any unusual noises and check their cause.

7.3 Annual checks

1. Check oil cooler connections.
2. Check propeller shaft alignment.
3. Check remote control operating linkage is accurately adjusted to give correct travel on the gearbox operating lever.

7.4 Winter storage

Drain water from the transmission oil cooler to avoid freezing or the collection of harmful deposits.

7.5 Other maintenance operations

1. The gearbox oil should be changed at periods which correspond to the intervals at which engine oil changes are carried out.
2. The gearbox oil should also be changed if it has been contaminated by water or if the gearbox has suffered major mechanical damage.

8. FAULT FINDING

The fault finding chart overleaf is designed to help diagnose some of the problems which might be encountered. It assumes that the installation and operating instructions in this manual have been followed and we advise that these are checked before proceeding to fault finding.

To avoid prejudicing warranty rights, no repair or other work should be done on the gearbox during the warranty period without first contacting NEWAGE TRANSMISSIONS plc., COVENTRY, or an authorised distributor or dealer, for advice.

SYMPTOM	NOTICEABLE EFFECT	CAUSE	REMEDY
No oil pressure	No drive ahead or astern	Damaged oil pump	Remove oil pump and examine. If possible replace gears and shafts with repair kit. If body damaged replace complete unit.
		Broken input drive plate.	Replace drive plate.
Loss of drive		Oil leaks	Check for evidence of leakage and rectify.
Low oil pressure to both clutches	Propeller speed does not increase with engine speed ahead and astern	Damaged or worn oil pump	Repair with kit or replace.
		Remote control cable or linkage not allowing F-N-R lever to move correct distance	Remove cable and operate lever by hand. Adjust cable if necessary.
Low oil pressure to one clutch	Propeller speed does not increase with engine speed in one direction only	Pressure relief valve spring defective	Remove valve block and replace spring.
		Piston rings worn. Feeder worn	Remove appropriate clutch shaft. Replace worn feeder or piston rings.
		Damaged 'O' ring in hydraulic circuit	Check 'O' rings in feeder connectors and piston.
		Blocked hydraulic passage in valve block	Remove valve block and examine.
Gearbox noise	Excessive noise from gearbox	Damaged clutch plates	Remove and examine clutch on appropriate shaft and replace if necessary.
		Input coupling defective	Remove, examine and replace if necessary.
		Gear rattle at low speed	Increase engine idling speed.
		Propeller shaft misalignment	Check the alignment of the propeller shaft coupling (see section 5.7); if necessary rectify by adjusting the shims under the engine mounts or the engine mounts themselves.
		Out-of-balance propeller	Remove the propeller and check that the pitch, weight, diameter and balance of all the blades are equal and rectify if necessary.
		Engine/gearbox misalignment	Remove the transmission and check that the flywheel face is flat and that the drive plate or flexible input coupling is correctly aligned.
		Defective bearing	Isolate defective bearing noise, remove and replace.
Excessively high oil temperature	Gearcase too hot to touch	Defective oil cooler	Replace oil cooler.
		Defective pressure relief valve	Remove and examine relief valve. Replace if necessary.
Gearbox oil consumption excessive	Oil level requiring constant topping up	Defective oil seal, gasket or 'O' ring	Clean the outside of the gearcase, particularly around the ends of shafts including the output shaft. Run the engine and observe the gearbox for leaks. Replace seals as required.
		Defective oil cooler	Check for traces of water in the gearbox oil or oil in the cooling water system. Replace cooler if necessary.
	Escape of high pressure in gearbox when dipstick is removed	Defective breather (causing leaks past oil seals)	Contact distributor or factory for advice.
Control lever on valve block stiff	Difficult to move single lever control	Defective valve or detent spring	Contact distributor or factory for advice.

9. SERVICING AND REPAIRS

The servicing, repair and replacement of components and assemblies on the input shaft and layshaft is made simple by the fact that the gearcase is constructed in two separate halves, the rear half being easily removable to give access to all shafts once the gearbox has been removed from the engine.

This can be further simplified by fitting complete replacement shaft assemblies, and where skilled service personnel or reasonable workshop facilities are not readily available, or where time and labour costs are of greatest importance, it may be found advantageous to adopt this procedure.

Exploded views of all internal components are contained in the parts list.

If the details outlined below are carefully followed no difficulty will be found in stripping and rebuilding the gearbox, but it is most important to ensure that all components are perfectly clean and in good condition before reassembly.

9.1 Selector valve assembly

The selector valve, operating lever and, where fitted, the neutral safety switch are integral parts of the gearbox design. The removal, inspection and replacement of components may be carried out without removal of the gearbox from the engine

1. Disconnect the oil cooler pipes and the control cable or cables from the lever on the control equipment.
2. Disconnect the wiring from the neutral switch - if fitted, unscrew the switch and washer and remove the steel operating ball from its recess. If it proves difficult it may be left in place until the selector valve has been removed.
3. Remove the nut and end washer (items C2 and C10) from the selector valve and withdraw the operating lever taking care not to lose or misplace the detent ball and spring.
4. Remove the 9 bolts securing the pump adaptor and manifold to the gearbox and withdraw the unit from the gearbox, taking care not to damage the gaskets or lose the 3 mm A/F socket wrench located in the pump adaptor. If the spacer and O ring (items C12 and C1) have remained in the pump adaptor and manifold, carefully remove these items.
5. The selector valve assembly can now be withdrawn from the gearcase, together with the high pressure valve and spring. If difficulty in removing steel operating ball was found previously, it can now be removed from the selector housing.
6. If the spacer and O ring (items C12 and C1) have remained on the nose of the selector valve, these should now be removed.
7. Inspect the valve components for damage or wear. Check that the valve spring has retained its correct free length (30.5 mm - 1.2 in.) and, if necessary replace.

To refit the selector valve assembly proceed as follows:-

8. With the high pressure valve and spring fitted in the selector valve, slide the selector valve into the housing until the spring seats on the bottom.
9. Ensure the adaptor and manifold gasket (item C7) is undamaged and also make sure that the 3 mm A/F socket wrench is housed in its recess in the adaptor. A liberable coating of grease on the wrench will ensure it is retained in the housing when refitting.
10. Refit the adaptor and manifold complete with gasket taking care not to damage the pump drive tang when locating in the drive slot.
11. Tighten the 9 bolts to a torque of 30 Nm (22 lbf.ft.).
12. Make sure the O ring (item C1) is undamaged and replaced if necessary.
13. Insert O ring and spacer into the recess in the adaptor and manifold until a spacer is flush with the rear face.
14. Refit the detent spring and ball, fit the operating lever tightening the lever nut to a torque of 21.6 Nm (16 lbf.ft.).
15. If required fit the neutral safety switch.
16. Refit the cooler pipes and cable.
17. Start up the engine and run until operating temperature is reached and check for leaks, correct operation of the clutches and oil pressure. A $\frac{1}{8}$ BSP tapping is provided on the pump adaptor and manifold for fitment of an oil pressure gauge connection.

The following section will assist when fitting the neutral safety switch.

18. Connect the switch terminals to a battery and bulb circuit.
19. Move the operating lever to the forward or astern position.
20. Insert the steel operating ball and fit the bonded seal to the switch.
21. Screw the switch into the housing with the circuit connected. The bulb should light.
22. Continue screwing the switch until the bulb goes out.
23. Move the operating lever to the neutral position, the bulb should now light. Check switch function in all three lever positions.
24. The switch can now be connected into the solenoid circuit on the engine starter motor.

9.2 Oil pump assembly

The oil pump assembly can be removed with the gearbox in position on the engine.

1. Follow the procedure as described in 9.1 - 1, 4 and 5.

2. The pump can now be stripped by removing the 4 fixing bolts in the cover plate. The assembly splits into its three component parts exposing the body, gears and shafts.
3. If the pump body is damaged, the complete pump assembly (item No. B) must be replaced. If the pump body is in good condition, the oil pump can be repaired using the pump repair kit (items No. B4 to No. B8 inclusive).

9.3 Removing the transmission from the boat.

1. Ensure that the gearbox operating lever is in the neutral position and disconnect the operating cable or cables, and disconnect the wiring from the neutral safety switch, if fitted.
2. Drain the gearbox oil into a suitable container and disconnect oil cooler pipes.
3. Unscrew and withdraw the bolts connecting the gearbox output flange from the flexible coupling or mating half coupling on the propeller shaft.
4. Remove the bolts securing the adaptor and gearbox to the engine and lift the gearbox and adaptor plate clear of the engine. Remove the 6 nuts and studs securing the gearbox to the adaptor and separate.

9.4 Removing the input shaft and layshaft assemblies

1. Remove the locknut (item F4) and washer (item F3) from the front end of the output shaft.
2. Remove the 4 bolts (item A5) holding the seal housing on the output shaft.
3. Using a hardwood mallet or drift, drive the output shaft through the gearcase half, leaving the output gear in the case.
4. Remove the 9 bolts (item A6) securing the front and rear gearcase halves and lift the front gearcase half clear of the clutch shafts and rear gearcase half. This operation will be easier if the gearcase is supported with the rear face down.

If a repair is to be carried out to the drive end bearing, thrust washers, pinion or clutch pack, this can be done without further dismantling of the unit. Details of these repairs are given in section 9.5.2.

Where inspection or replacement of the clutch gear, feeder or rear bearing is required, continue as below.

5. Remove the pump adaptor and manifold as described in section 9.1.
6. Remove the circlip (item D20) from the rear of the clutch shaft and withdraw the shaft from the bearing and feeder.
7. The input and layshaft can now be worked on as separate assemblies.

9.5 Servicing Input Shaft and Layshaft Assembly Components

9.5.1 Oil seal

1. Remove the gearbox from the engine and separate from the adaptor plate as described in section 9.3.
2. Using a suitable wrench hold the oil seal housing spigot and gently rotate the housing while withdrawing it from the gearcase. Care must be taken not to damage the spigot. Check the condition of the O ring and replace if damaged.
3. With a suitable drift, remove the oil seal from the housing, noting the position in which the seal was fitted.
4. Fit new seal (item D23) in the housing and refit the housing.

9.5.2 Drive end bearing

To renew a damaged or worn bearing, proceed as follows:

1. Support the shaft in a vice.
2. Remove the circlip (item D20 or E20) securing the bearing inner race and rollers.
3. Remove the clutch pinion, thrust washer and bearing using pulley extractors with the jaws of the extractor located behind the pinion.
4. Refit the pinion to the shaft.
5. Refit the thrust washer (item D8) inspecting for wear or damage and replace where necessary.
6. Locate the new bearing (item D25) on the shaft and, using a drift or hand press, gently drive into position, taking care not to damage the bearing rollers or raceway during this operation.
7. Refit the circlip, replacing if necessary.
8. Remove the bearing outer race from the front gearcase half using a drift against the layshaft cover or input seal housing.
9. Locate the new bearing outer race in the bore and drive into position using the layshaft cover or input seal housing and a drift. When the face of the layshaft cover or seal housing is flush with the gear case, the bearing race is in its correct position.

9.5.3 Clutch assembly

Clutch plates which are discoloured by overheating, or worn down to the extent of having lost their grooved patterns, will tend to slip. If either of these conditions occur, the clutch assembly will need to be replaced as follows:

1. Remove the drive pinion bearing as previously described.
2. Unlock and remove 3 nuts (item D11) securing the clutch pack.
3. Withdraw the complete clutch from the shaft noting the position of the pull off springs.
4. Position shaft upright and locate the 3 spring guide pins in the gear and the ferrules over the 3 bolt holes.
5. Fit the clutch end plate (item D4) over the spring guide pins and place the return springs over the guide pins, resting on the end plate. Then, starting with one of the driven plates, build up the replacement clutch pack onto the clutch end plate.
6. Replace the end cover (item D17) onto the clutch pack, refit the 3 securing bolts and nyloc nuts. Lightly tighten the nyloc nuts.
7. Ensure the pull off springs are correctly located and the clutch plates are free to travel in the clutch body.
8. Tighten the nuts to a torque of 12.2 Nm (9 lbf.ft).
9. Replace the drive pinion by turning it slightly as it is inserted into the driven clutch plates until it touches the bottom thrust washer.
10. Place the thrust washer and bearing onto the shaft and gently drive the bearing into position.
11. Replace the circlip.

9.5.4 Clutch gear

Where a clutch gear has been damaged or badly worn, both clutch gears must be replaced.

1. Remove input and layshaft assemblies as previously described.
2. Remove the bearings, thrust washers, circlips and clutch assembly from both shafts.
3. Remove the piston rings from the clutch gears.
4. The clutch gear and shaft assemblies are factory assembled units only. Refit piston rings to the clutch gears.
5. Fit new O rings to the shaft and pistons.
6. Rebuild the clutch shaft assemblies, replacing any worn, damaged or defective parts.

9.5.5 Drive pinion

As with the clutch gears it is advisable to renew both drive pinions simultaneously. To ensure that the drive pinion of the correct ratio is used please refer to the parts at the back of this manual. If it is required to fit a ratio which is different to that which was originally supplied, the output gear as well as both pinions will need to be changed.

To replace the drive pinion, follow the procedure set out in section 9.5.2.

9.5.6 Rear bearing

To replace a worn or damaged rear bearing proceed as follows.

1. Remove clutch shaft assembly as described previously.
2. Withdraw the bearing from the rear case half using pulley extractors.
3. Using a drift, or hand press, fit the new bearing into the housing up to the shoulder.
4. Refit the clutch shaft assembly.

9.5.7 Clutch feeder

1. Remove the clutch assembly as previously described.
2. Remove the bearing from the rear case half using pulley extractors.
3. Using a hand press and a suitable plug, remove the feeder from the gearcase.
4. Refit the rear clutch shaft bearing as described in section 9.5.6.
5. Check the new feeder to ensure the outside diameter is clean and free from dirt.
6. Lay the rear case half on a firm surface, rear face down position the feeder on the mouth of the housing, ensuring the internal chamfer on the feeder is at the clutch gear end.
7. Using a hand press drive the feeder into the housing until it abuts firmly against the bearing.

9.5.8 Piston rings

Excessive wear or damage may necessitate renewal of the piston rings as follows.

1. Remove the clutch assembly as previously described.
2. Use a piston ring extractor or a piece of thin steel to remove the rings from the clutch gear.

3. Raise one end of the top ring out of the groove and insert the steel strip between the ring and the clutch gear. Rotate the strip around the clutch gear, applying slight forward pressure to the raised portion of the ring until it rests on the land above the groove. The ring can then be eased off the gear. Repeat for the second ring.
4. Clean off any grease or rust inhibitor from the new rings (items D26 or E26).
5. If a ring loading tool is available, fit this around the shaft, load the rings onto the tool and locate in their approximate position. Gently withdraw the tool and allow the rings to locate in their respective grooves.
6. Where a loading tool is not available, use a thin metal strip, long enough to lay along the shaft above the grooves. Expand each ring just sufficiently to allow it to be placed in its approximate position over the strip. Gently withdraw the strip and locate the rings in their respective grooves.

9.6 Replacement of input shaft and layshaft assemblies

1. Position the rear case, back face down, on a firm surface with the rear bearing removed.
2. Position the clutch shaft assembly and manoeuvre the piston rings onto the clutch gear into the feeder bore and push the assembly fully home against the feeder.
3. Fit the rear clutch shaft bearing into the housing up to the shoulder and fit the circlip (item E24).
4. Position the output seal housing on the output shaft and fit the output bearing and circlip.
5. Insert the output shaft assembly into the rear gearcase half until the bearing fully abuts against the housing shoulder.
6. Coat the surface of the oil seal housing with a silicon R.T.V. sealing compound and insert four bolts to secure the seal housing, tightening to a torque of 30 Nm (22 lbf.ft).
7. Fit the circlip (item F8) locating the output bearing on the output shaft.
8. Locate the output gear on the output shaft.
9. Coat the mating surfaces of the gearcase halves with a non solidifying sealing compound.
10. Fit the front case half, fitted with the clutch shaft bearing outer races, end cover, and input oil seal housing, to the rear case half. Care should be taken not to damage the oil seal on the input shaft spline, and a piece of tape covering the spline teeth will help avoid oil seal damage.

11. Refit the nine bolts and self locking nuts securing the case halves and tighten to a torque of 30 Nm (22 lbf.ft).
12. Refit the output shaft front bearing onto the output shaft until it strikes against the output gear.
13. Refit the lock nut and washer (items F4 and F3) tightening to a torque of 135.6 Nm (100 lbf.ft).
14. Refit the pump adaptor and manifold as previously described.
15. Check that the layshaft and cover and input oil seal housing both sit flush with the front face.
16. Apply silicon R.T.V. sealing compound to the front face as close as possible around the output shaft front bearing and refit the adaptor plate, tightening to a torque of 30 NM (22 lbf.ft).
17. Refit the gearbox to the engine in the reverse order as previously described

9.7 Servicing the output shaft assembly

1. Removal of the output assembly will necessitate removing the gearbox from the boat (see section 9.3).
2. Remove input shaft, layshaft and output assemblies as described in section 9.4.

9.7.1 Front bearing and output gear

1. Having removed the output shaft from the gearbox, and the two gearbox halves separated, the output gear (F10) can now be lifted clear from the gearcase.
2. Examine the output gear and if worn or damaged, replace the output gear and the two pinions with new gears of the same ratio.
3. If the bearing is found to be worn or damaged, replace it, but also ensure the gears have not been damaged due to dirt or swarf. Conversely, if a gear is found to be defective, examine the bearings for damage.

9.7.2 Rear bearing and oil seal replacement

1. Remove the circlip (item F8) locating the output bearing and remove the bearing and oil seal housing from the shaft.
2. If the oil seal is to be replaced, extract the old oil seal and when fitting the new seal (item F2) ensure it is driven squarely into the housing.
3. Reposition the oil seal housing on the shaft.

4. If output bearing (item F9) is worn or damaged replace with new bearing and refit the circlip locating the output bearing.

9.7.3 Re-assembling output shaft assembly

Reassembly of output shaft as described in section 9.6.

10. TIGHTENING TORQUES

	Nm	lbf.ft	Kgfm
Front to rear gearcase bolts	30.0	22.0	3.1
Pump adaptor/manifold to gearcase	30.0	22.0	3.1
Oil seal housing to gearcase	30.0	22.0	3.1
Output shaft locknut (tabbed)	135.6	100.0	13.8
Operating lever to selector valve	22.0	16.0	2.2
Clutch pack	12.2	9.0	1.2
Adaptor plate to gearcase	30.0	22.0	3.1

REPLACEMENT PARTS ORDERING

When ordering replacement parts the following should be quoted:

- a) Gearbox model and serial number
- b) Description(s) and part number(s) of the component(s) required
- c) Quantity required

NOTES

- 1 Individual items which form part of an assembly, or main components, are indented and may be supplied separately; if the assembly is ordered all components pertaining to that assembly are supplied. For example, if the 'clutch input shaft' assembly is ordered the shaft itself and every item called up and shown on the corresponding illustration will be supplied, with the exception of the end housing and oil seal. The same applies to the layshaft.
- 2 Clutch plate assemblies, i.e. end plates, driven plates and driver plates are supplied in sets.

Orders and enquiries for replacement parts should be addressed to:

**NEWAGE TRANSMISSIONS LIMITED
BARLOW ROAD
COVENTRY CV8 2LD
ENGLAND**

Tel: 01203 617141 Fax: 01203 611845

METRIC DIMENSIONS

Where metric dimensions are shown in the description column, or without brackets in the remarks column, i.e. bearing dimensions, these are actual dimensions.

Where metric dimensions are shown within brackets in the remarks column, these are equivalent metric dimensions to imperial and are intended to assist identification of components only.

PARTS LIST

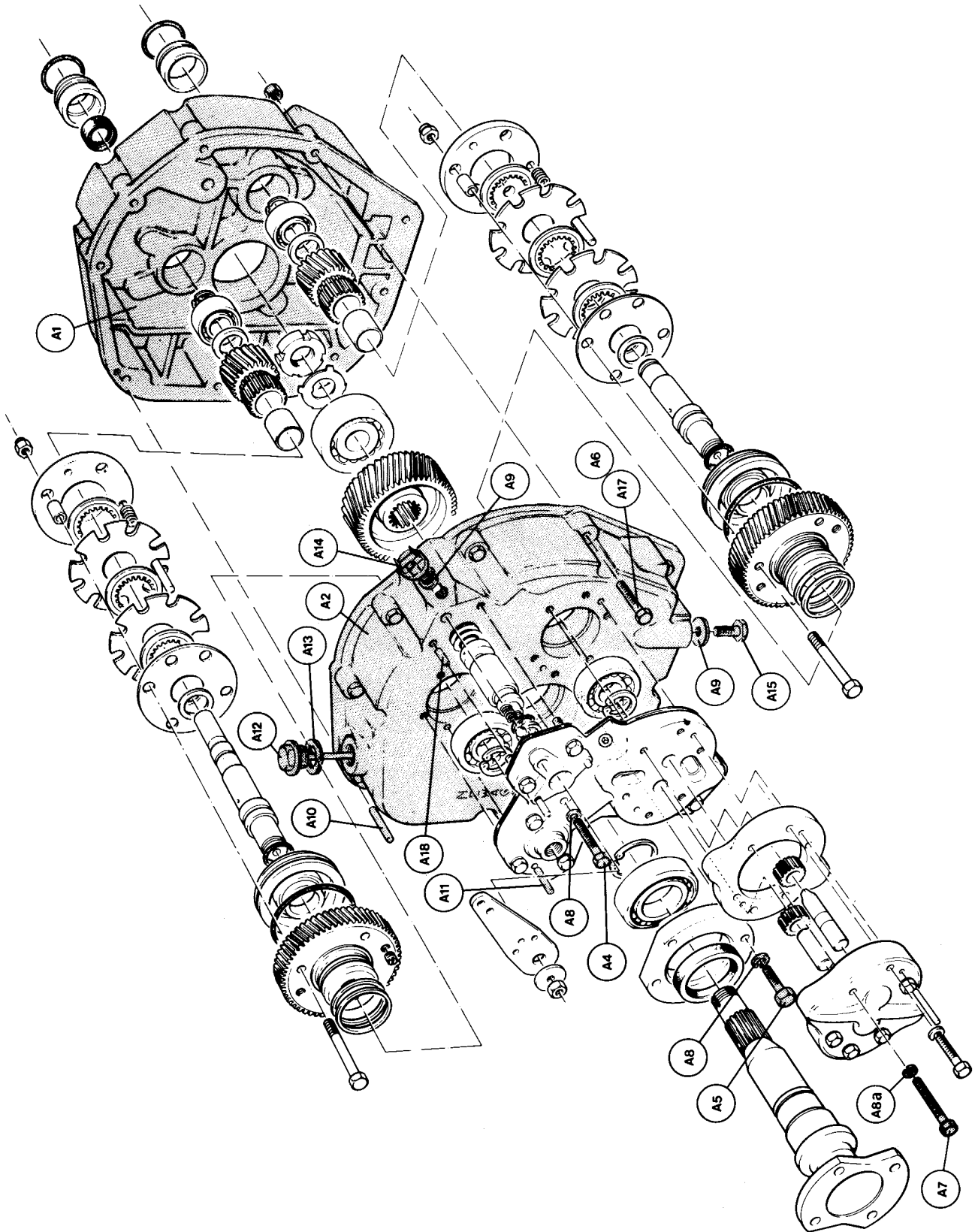

Plate Ref.	Description	DELTA Part No.	Qty.	Remarks
<p>A</p> <p>A1</p> <p>A2</p> <p>A3</p> <p>A4</p> <p>A5</p> <p>A6</p> <p>A7</p> <p>A8</p> <p>A8a</p> <p>A9</p> <p>A10</p> <p>A11</p> <p>A12</p> <p>A13</p> <p>A14</p> <p>A15</p> <p>A16</p> <p>A17</p> <p>A18</p> <p>* IF SWITCH AND BALL ARE NOT FITTED, THE TAPPING WILL BE BLANKED - OFF</p>	<p>G/case assembly comprising:</p> <p>Gearcase front</p> <p>Rear gearcase S/A</p> <p>Rear gearcase</p> <p>Feeder</p> <p>Ball</p> <p>Screw</p> <p>Bolt</p> <p>Bolt - case half</p> <p>Bolt</p> <p>Spring washer</p> <p>Spring washer</p> <p>Bonded seal</p> <p>Dowel</p> <p>Dowel</p> <p>Dipstick</p> <p>Washer</p> <p>Switch</p> <p>Drain plug</p> <p>Ball</p> <p>Nut - case half</p> <p>Socket wrench</p>	<p>MT3000</p> <p>MT3001 S/A</p> <p>MT3001</p> <p>MT3015</p> <p>066M060</p> <p>0040808ZP</p> <p>0040809ZP</p> <p>0040812ZP</p> <p>0040815ZP</p> <p>0191105ZP</p> <p>CPI223</p> <p>0191716</p> <p>0210620</p> <p>022D304</p> <p>0800550</p> <p>CPI068</p> <p>CPI358</p> <p>CPI360</p> <p>066M080</p> <p>0050810</p> <p>CPI362</p>	<p>1</p> <p>1</p> <p>1</p> <p>2</p> <p>2</p> <p>7</p> <p>4</p> <p>9</p> <p>2</p> <p>11</p> <p>2</p> <p>2</p> <p>2</p> <p>2</p> <p>2</p> <p>1</p> <p>1</p> <p>1</p> <p>2</p> <p>1</p> <p>9</p> <p>1</p>	<p>Not illustrated</p> <p>* If fitted</p> <p>* If fitted</p> <p>3mm Not illustrated</p> <p>WITH PLUG CPI360</p>

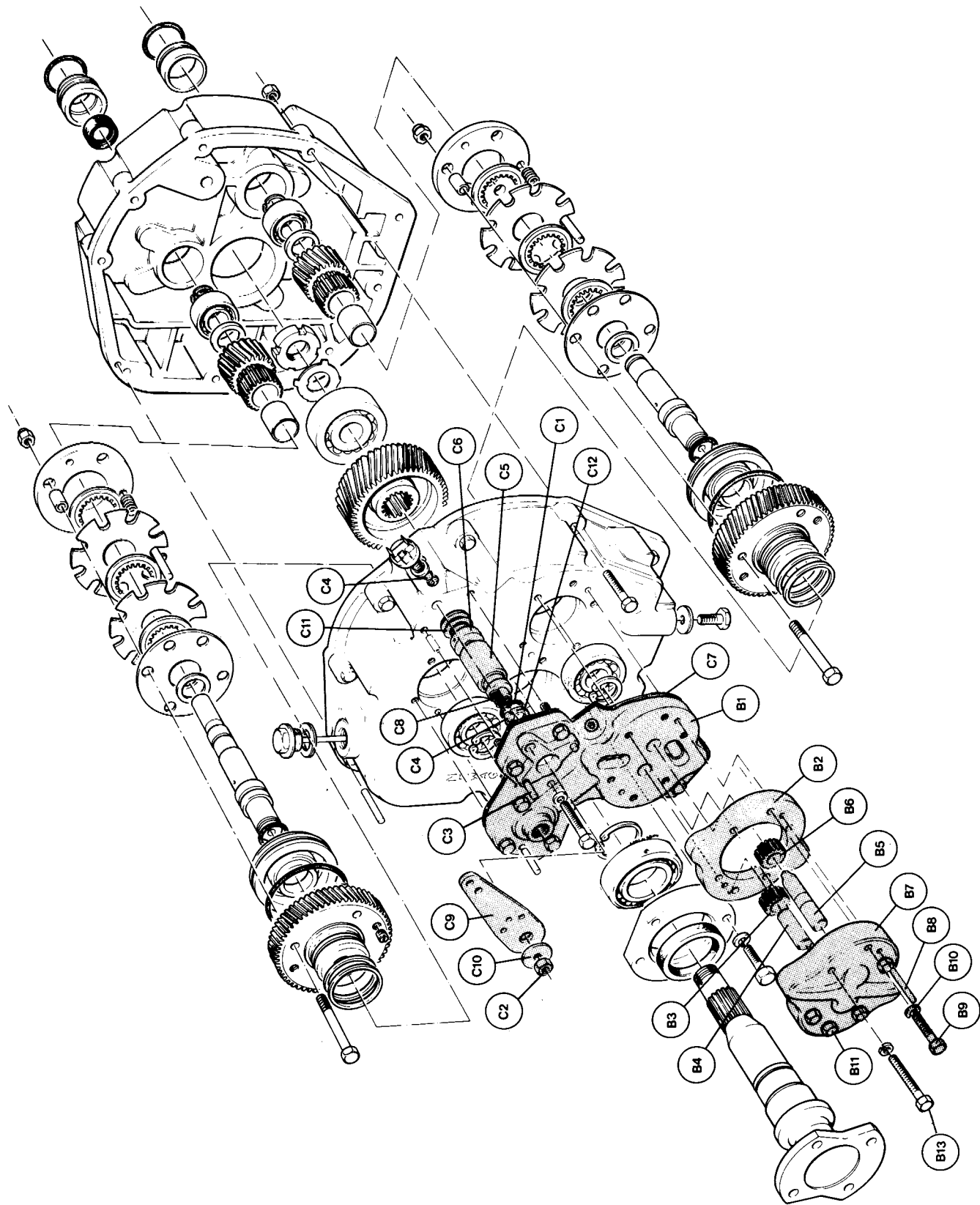

Plate Ref.	Description	DELTA Part No.	Qty.	Remarks
B	Oil pump assembly comprising:	MT0162	1	
B1	Manifold	MT3013	1	Not supplied separately
B2	Pump plate	MT320	1	Not supplied separately
B3	Pump repair kit comprising:	MT0163	1	Not supplied separately
B4	Pump gear	MT323	1	Not supplied separately
B5	Pump spindle	MT325	1	Not supplied separately
B6	Pump spindle S/A	MT3028 S/A	1	Not supplied separately
B7	Spindle	MT3028	1	Not supplied separately
B8	Pump gear	MT323	1	Not supplied separately
B9	Pump cover	MT3049	1	
B10	Dowel	MT356	2	
B11	Bolt	0040810ZP	2	
B12	Seal Washer	CP1223	6	
B13	Bolt	0040809ZP	2	
	Pressure plug	MT311	1	Not illustrated
	Bolt	0040815	2	

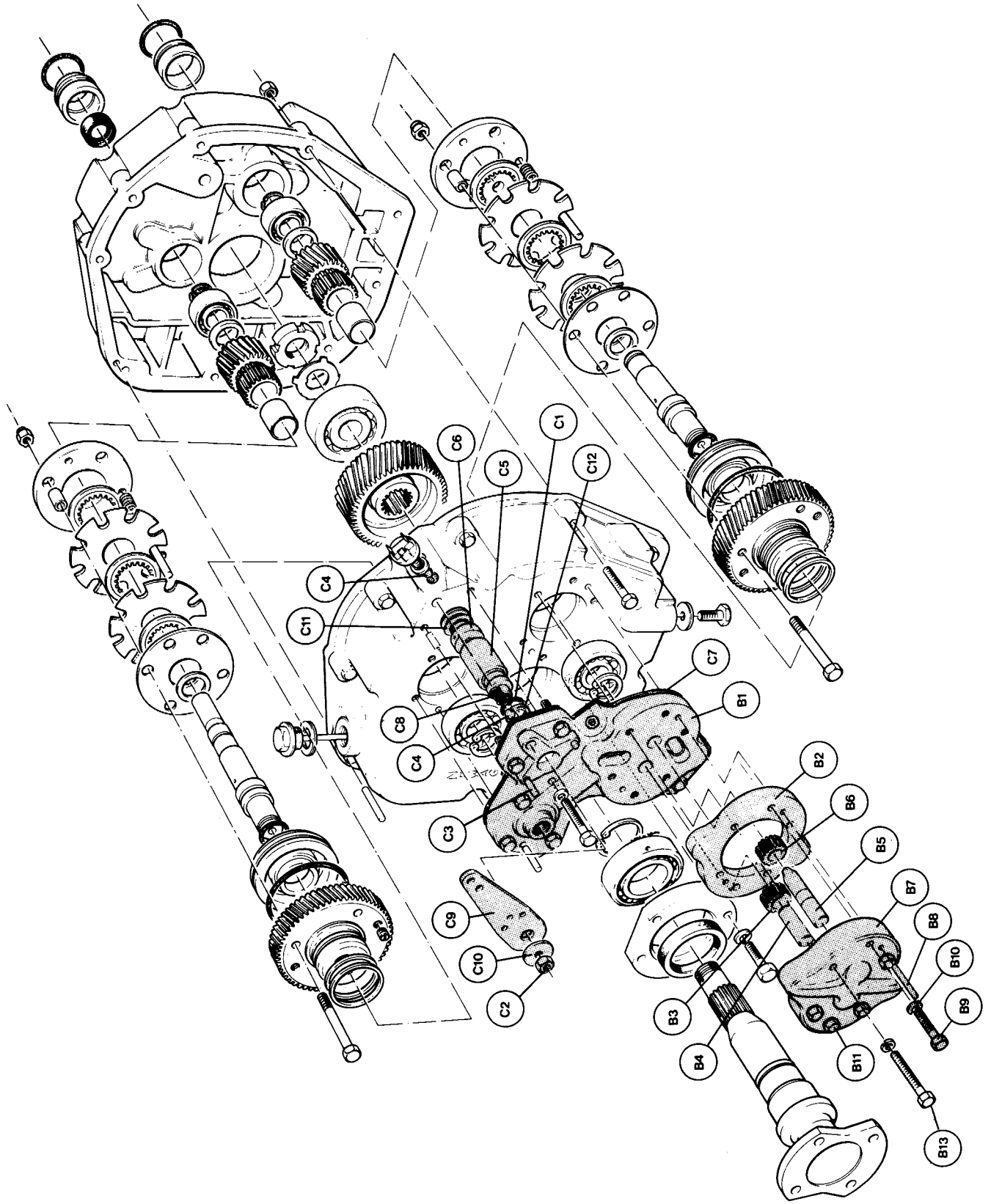

Plate Ref.	Description	DELTA Part No.	Qty.	Remarks
C	Valve block assembly:			
C1	O ring	04301525	1	
C2	Nut	0050810	1	
C3	Pin	028S308	2	
C4	Steel ball	066M080	1	
C5	Selector valve	MT3025	1	
C6	Relief valve	MT3026	1	
C7	Gasket	MT3029	1	
C8	Spring	MT3045	1	
C9	Operating lever	MT977	1	
C10	Washer	MT979	1	
C11	Spring	MT3051	1	
C12	Spacer	MT3052	1	

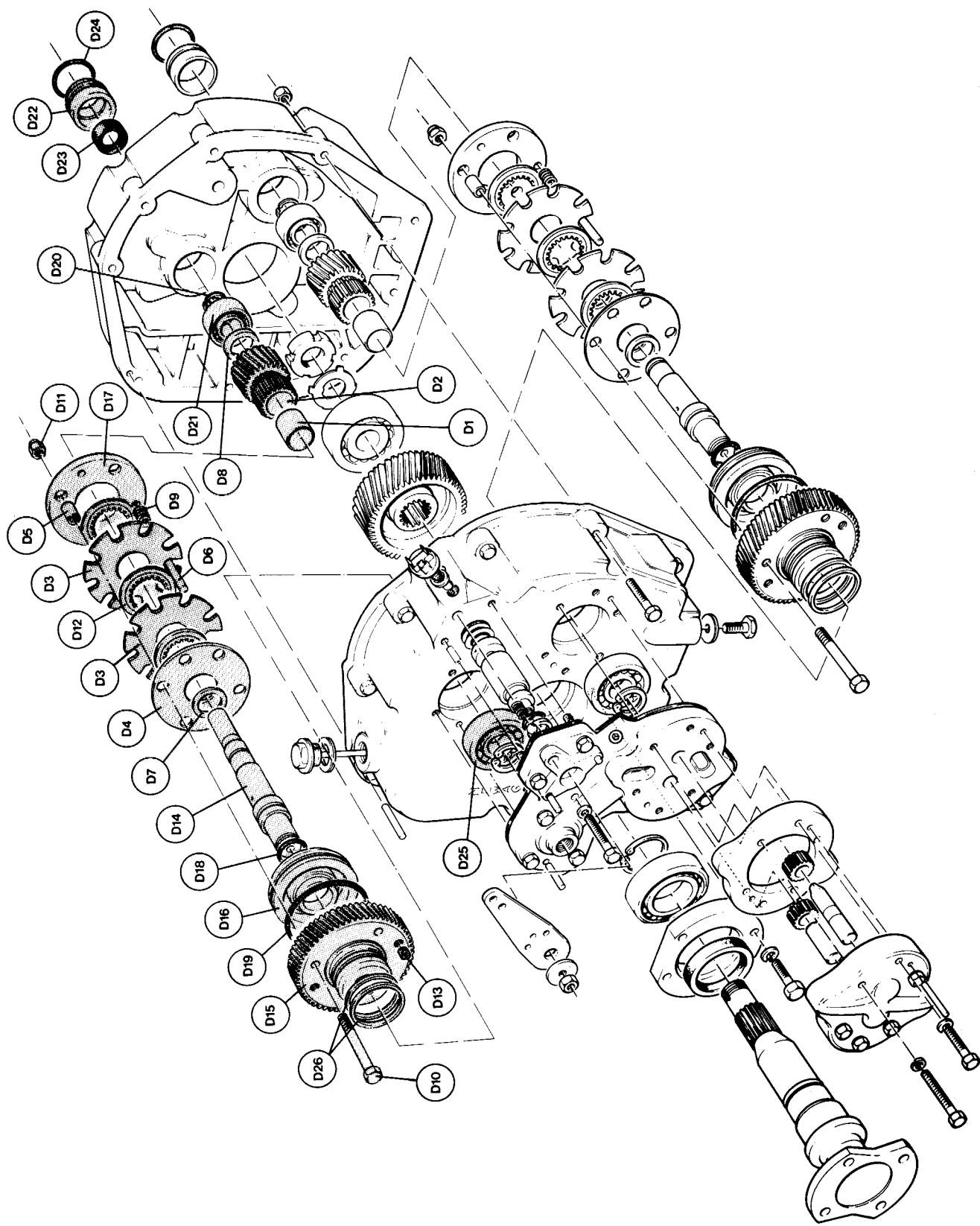

Plate Ref.	Description	DELTA Part No.	Qty.	Remarks
D	Mainshaft assembly			
D1	Pinion & bush S/A	MT0144/D15	1	1.5:1 reduction
D2	Bush	0382225	1	Part of MT0144/D15
D1	Pinion & bush S/A	MT3011	1	Part of MT0144/D15
D2	Bush	MT0144/D20	1	2:1 reduction
D1	Pinion & bush S/A	0382225	1	Part of MT0144/D20
D2	Bush	MT3009	1	Part of MT0144/D20
D1	Pinion & bush S/A	MT0144/D30	1	3:1 reduction
D2	Bush	0382225	1	Part of MT0144/D30
D3	Pinion	MT3007	1	Part of MT0144/D30
D4	Clutch pack comprising:	MT0164	1	
D5	Clutch plate	MT116	2	
D6	Clutch end plate	MT117	1	
D7	Ferrule	MT3066	3	
D8	Guide pin	MT3021	3	
D9	Thrust washer	MT3022	1	
D10	Thrust washer	MT3023	1	
D11	Spring	MT3024	3	
D12	Special bolt	MT3071	3	
D13	Nyloc nut M6 HT	0050606HT	3	
D14	Clutch plate	MT731/S	3	
D15	Grub screw	014F420L	2	
D16	Mainshaft	MT3070S/A	1	Supplied as part of MT3070 S/A. For boxes with suffix B23 order MT3065S/A
D17	Clutch gear	MT3069	1	
D18	Piston	MT3014	1	
D19	Clutch end plate	MT3067	1	

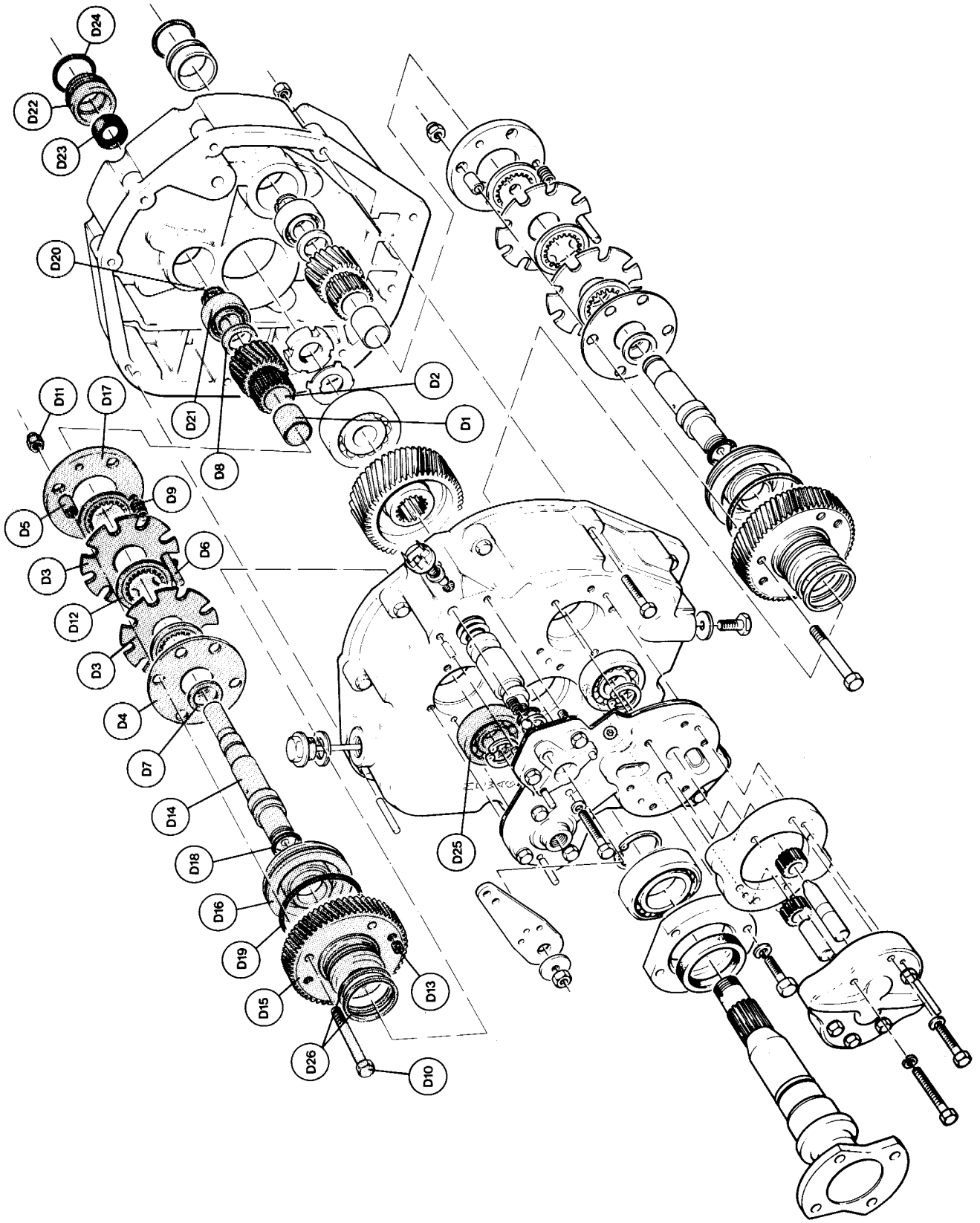

Plate Ref.	Description	DELTA Part No.	Qty.	Remarks
D18	O ring	001123	1	
D19	O ring	002874	1	
D20	Circlip	0330200	1	
D21	Bearing	0532023	1	
D22	Input seal housing S/A	MT3018 S/A	1	
D23	comprising: Seal housing	MT3018	1	
D24	Oil seal	0400203	1	
D25	O ring	0430413	1	
D26	Ball bearing	0512030	1	
	Piston ring	MT369	2	

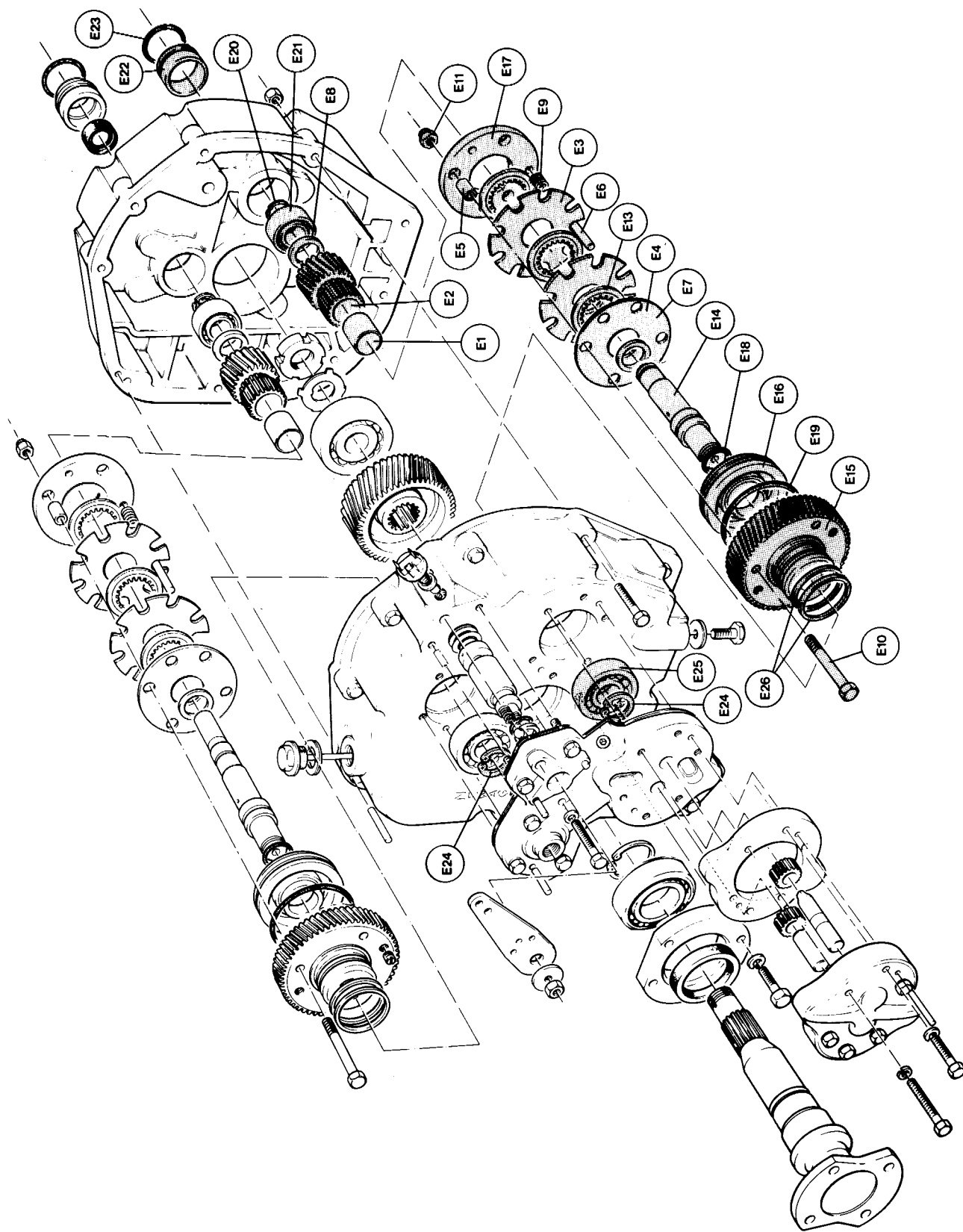

Plate Ref.	Description	DELTA Part No.	Qty.	Remarks
E	Layshaft assembly	MT0144/D15	1	1.5:1 reduction
E1	Pinion & bush S/A	0382225	1	Part of MT0144/D15
E2	Bush	MT3011	1	Part of MT0144/D15
E1	Pinion & bush S/A	MT0144/D20	1	2:1 reduction
E2	Bush	0382225	1	Part of MT0144/D20
E1	Pinion & bush S/A	MT3009	1	3:1 reduction
E2	Bush	MT0144/30	1	Part of MT0144/D30
E3	Pinion	0382225	1	Part of MT0144/D30
E4	Clutch pack comprising:	MT3007	1	Part of MT0144/D30
E5	Clutch plate	MT0164	1	
E6	Clutch end plate	MT116	2	
E7	Ferrule	MT117	1	
E8	Guide pin	MT3066	3	
E9	Thrust washer	MT3021	3	
E10	Thrust washer	MT3022	1	
E11	Spring	MT3023	1	
E12	Special bolt	MT3024	3	
E13	Nyloc nut M6 HT	MT3071	3	
E14	Clutch plate	0050606HT	3	
E15	Layshaft	MT731/S	1	Supplied as part of
E16	Clutch gear	MT3003	1	MT3003 S/A
E17	Piston	MT3068	1	
E18	Clutch end plate	MT3014	1	
E19	O ring	MT3067	1	
E20	O ring	001123	1	
E21	Circlip	002874	1	
E22	Bearing	0330200	1	
E23	Layshaft cover	0532023	1	
E24	O ring	MT3020	1	
E25	Circlip	0430413	1	
E26	Ball bearing	0330200	2	
	Piston ring	0512030	1	
		MT369	2	

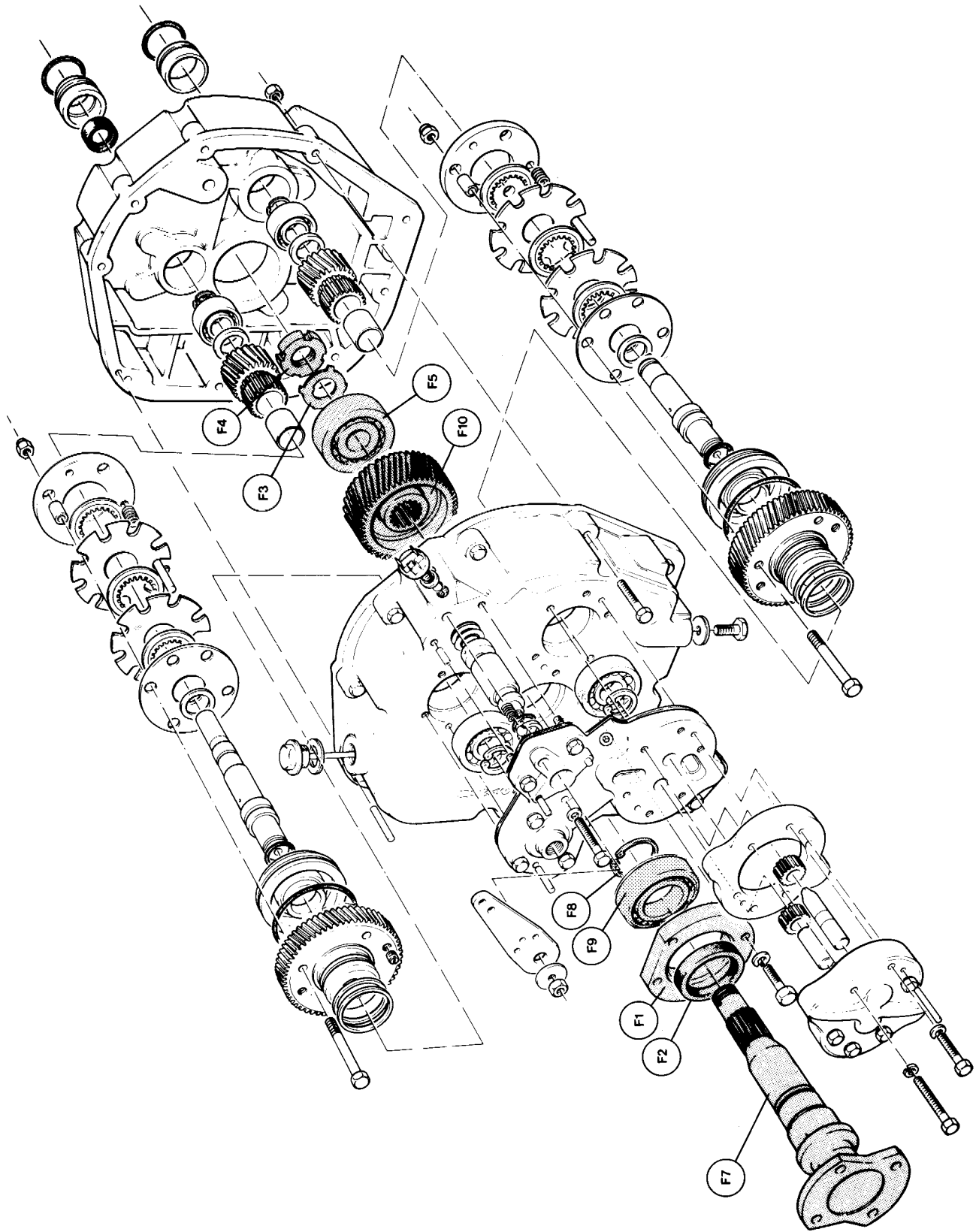

Plate Ref.	Description	DELTA Part No.	Qty.	Remarks
F	Output shaft	MT3017 S/A	1	
F1	End cover	MT3017	1	
F2	Oil seal	0400451	1	
F3	Lock washer	010W251	1	
F4	Locknut	010N251	1	25mm
F5	Bearing	AM161	1	
F7	Output shaft	MT3053	1	
F8	Circlip	0330350	1	
F9	Bearing	CM2017	1	
F10	Output gear	MT3012	1	1.5:1 reduction
F10	Output gear	MT3010	1	2:1 reduction
F10	Output gear	MT3008	1	3:1 reduction
F11	Spacer	MT3089	1	Not illustrated

KITS OF PARTS

Part No.	Description	Qty
MT0163	Pump repair kit	
MT323	Pump gear	1
MT325	Pump spindle	1
MT3028 S/A	Pump spindle S/A	1
MT0164	Clutch Pack	
MT116	Clutch plate	2
MT117	Clutch end plate	1
MT3066	Ferrule	3
MT3021	Guide pin	3
MT3022	Washer	1
MT3023	Washer	1
MT3024	Spring	3
MT3071 HT	Special bolt	3
MT731/S	Clutch plate	3
0050606 HT	NYloc nut	3
MT3067	Clutch end plate	1
MT0165	O Ring Kit	
001123	O ring	2
002874	O ring	2
0400203	Oil seal	1
0400451	Oil seal	1
0430413	O ring	2
MT3029	Gasket	1
04301525	O ring	1
0430661	O ring	1

Part No.	Description	Qty
MT0391	Valve Block Gasket Kit	
MT3029	Gasket	1
04301525	O ring	1
	Conversion Kit 1.5:1	
MT0144/D15	Pinion S/A 1.5:1	2
MT0165	O ring kit	1
MT3012	Wheel 1.5:1	1
	Conversion kit 2:1	
MT0144/D20	Pinion S/A 2:1	2
MT0165	O ring kit	1
MT3010	Wheel	1
	Conversion Kit 3:1	
MT0144/D30	Pinion S/A 3:1	2
MT0165	O ring kit	1
MT3008	Wheel	1