

 **West Marine**[®]

VHF500



DSC Fixed Mount Marine Radio

*Poste de radio maritime d'appel numérique
sélectif (DSC) à monture fixe*

Radio Marino DSC de Mantaje Fijo

Maritime Radio Services Operation

Warning!

This transmitter will operate on channels/frequencies that have restricted use in the United States. The channel assignments include frequencies assigned for exclusive use of the U.S. Coast Guard, use in Canada, and use in international waters. Operation in these frequencies without proper authorization is strictly forbidden. For frequencies/channels that are currently for use in the U.S. without an individual license, please contact the FCC Call Center at 1-888-CALL-FCC.

For individuals requiring a license, such as commercial users, you should obtain a license application from your nearest FCC field office.

West Marine works to reduce lead content in our PVC coated cords in our products and accessories.

WARNING: The cords on this product and/or accessories contain lead, a chemical known to the State of California to cause birth defects or other reproductive harm. ***Wash hands after handling.***

Contents

West Marine VHF500	5
Included with your VHF500	6
Controls and Indicators.....	7
Installation.....	11
Choosing a Location.....	11
Engine Noise Suppression.....	13
Antenna Considerations	13
Antenna Selection and Installation	13
Installing the VHF500.....	14
Operation.....	15
Power On/Off.....	15
Last Channel Memory	15
Squelch.....	16
Hailing and Distress Channel 16/Channel 9 Communications	17
Marine Distress Procedure.....	17
Triple Watch.....	18
Selecting a Channel	18
Weather Channels	19
Entering Channel Numbers into Memory Scan.....	19
Memory Channel Scan.....	20
Triple Watch Alert Scan	20
Alert Scan.....	20
Weather Alert.....	21
About S.A.M.E. Weather Alert	21
Setting the Transmit (TX) Power	23
Menu Operation.....	24
Digital Selective Calling (DSC).....	25
Distress.....	25
Individual Call.....	27
Group Call.....	28
All Ships Call.....	29
Position Request.....	31
Position Send.....	32
Standby.....	33
Call Wait.....	34

Setup	36
Alarm Clock.....	36
Local Time Adjust.....	39
Daylight Savings On/Off.....	40
Directory.....	41
FIPS	45
Auto Channel Switch.....	48
Position Reply	49
Channel Name	51
WHAM.....	53
Group MMSI.....	56
User MMSI	57
System.....	59
Contrast.....	59
Lamp Adjust	60
Key Beep	61
NMEA Technical Setup	62
Optional Accessories	62
VHF FM Marine Radio Telephone	
Channel and Functions (USA Channels)	63
Channel and Functions (International Channels)	64
Channel and Functions (Canadian Channels).....	65
NWR-SAME Event Code.....	66
Specification	67
Troubleshooting	68
Care and Maintenance	70
Three Year Limited Warranty.....	71

West Marine VHF500

The West Marine **VHF500** is of all solid-state design with conservatively rated, rugged components and materials compatible with the marine environment. The transceiver utilizes a number of gaskets, sealing rings, waterproof membranes, and other sealants to effect a waterproof housing for protection of the electronics. It meets the most stringent JIS7 waterproof specification. The unit may be mounted in any number of convenient locations on your vessel by utilizing the optional flush mount bracket (White - 500FMW, Black - 500FMB).

You are encouraged to thoroughly read the rest of this Operating Guide to acquaint yourself with the characteristics and operation of your transceiver so that you can contribute to the longevity of your investment.

Keep your receipt as proof-of-purchase in case warranty service is required.

Features, specifications, and availability of optional accessories are all subject to change without notice.

Note: **VHF500** meets JIS7 requirements. This means that the radio and mic are rated submersible to a depth of 1 meter for 30 minutes.

Included with your VHF500

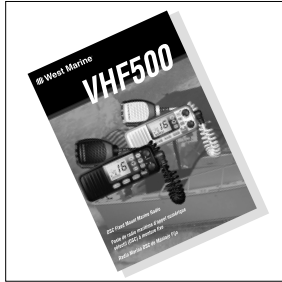

VHF500
Owner's Manual

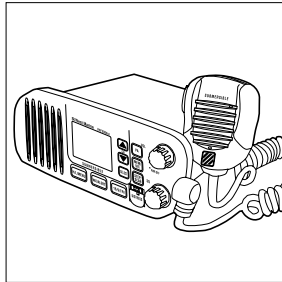

VHF500 Radio

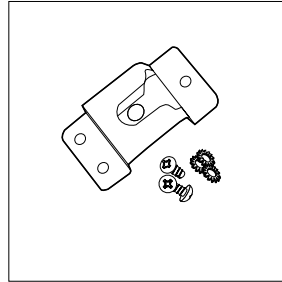

Microphone Hanger
and Screws

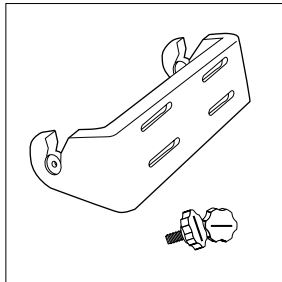

Mounting Bracket
and Knobs

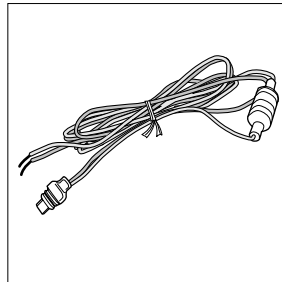

DC Cord

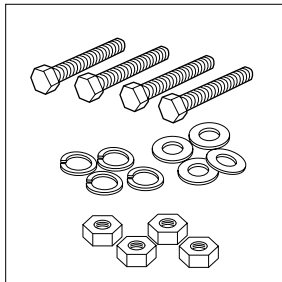

Mounting Hardware

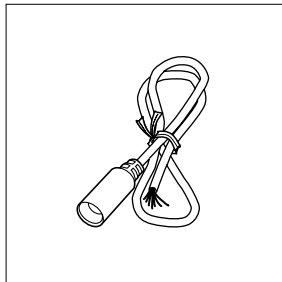

Accessory Cable

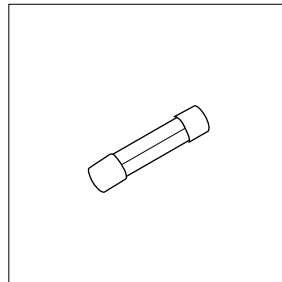

Spare Fuse
250V 6A

Controls and Indicators

Front panel/Microphone

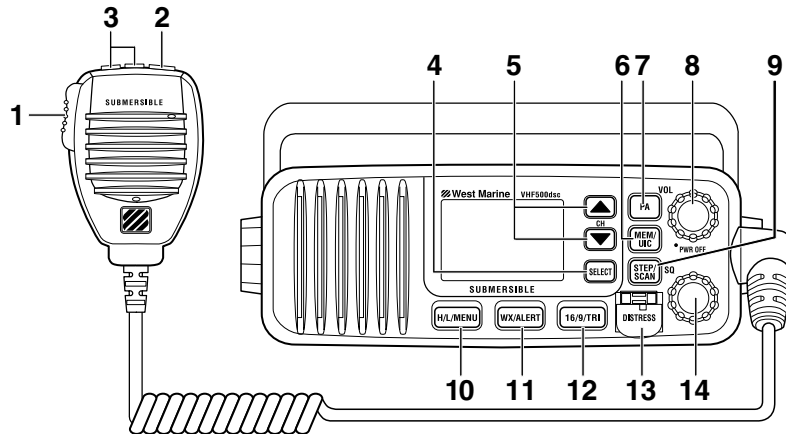

1. **PTT Switch** - Press to transmit and release to receive.
2. **16/9/TRI** - Press this key briefly to instantly change to Channel 16, Channel 9 or current channel. Press this key for more than two seconds to activate the triple Watch Feature.
3. **CH(CHANNEL)/▲(+)/▼(-)** - These keys are used to change the channel number up/down. These buttons are also used to move the cursor in Menu mode.
4. **SELECT** - In the Menu mode this is used to select the menu options.
6. **MEM/UIC** - Press this key briefly to place the currently selected channel into Memory. Press this key briefly again to delete the channel from scanning memory. Press this key for more than two seconds to change channel modes. (USA, International, or Canadian)
7. **PA** - Press this key briefly to enable the PA (Public Address) feature.
8. **PWR/VOL (On/Off/Volume)** - Turns the unit On or Off and adjusts the speaker volume.
9. **STEP/SCAN** - Press this key briefly to activate the step operation. Every time this key is pushed, the radio will step to the next channel that has been placed into Memory. Press this key for more than two seconds to activate the memory channel scan feature.
10. **H/L/MENU** - Press this key briefly to change the transmit power to either High (25 watts) or Low (1 watt). Press this key for more than two seconds to enter the Menu mode.
11. **WX/ALERT** - Press this key briefly to listen to active NOAA Weather channels. Press this key for more than two seconds to place the radio into the Weather Alert mode.
13. **DISTRESS** - Lift the flap and press this key for 5 seconds to send a distress signal in case of emergency.
14. **SQUELCH** - Rotate this knob clockwise to eliminate background noise when a signal is not being received.

Rear Panel Connectors

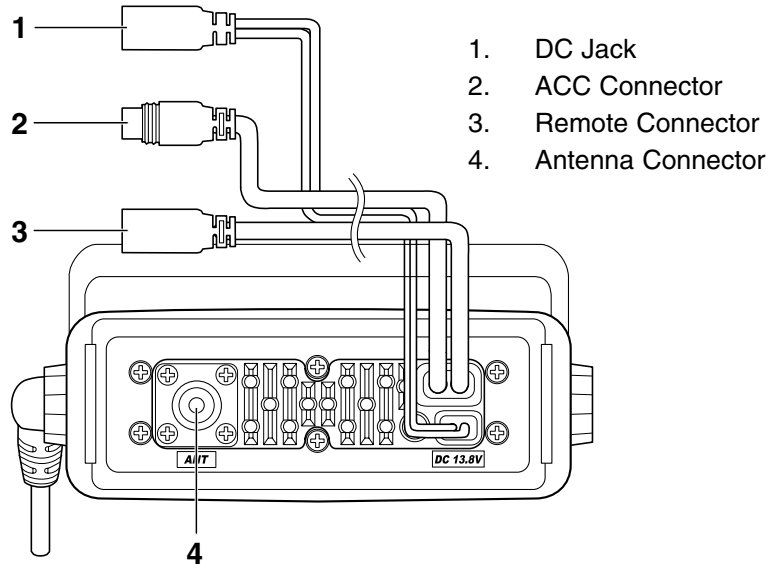

ACC Connector

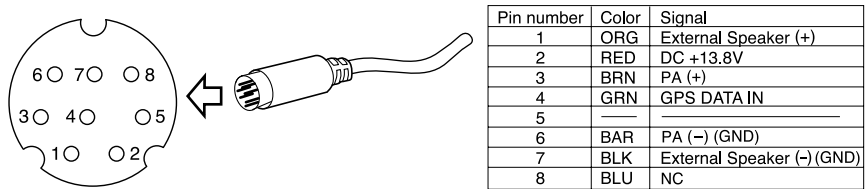

To VHF500

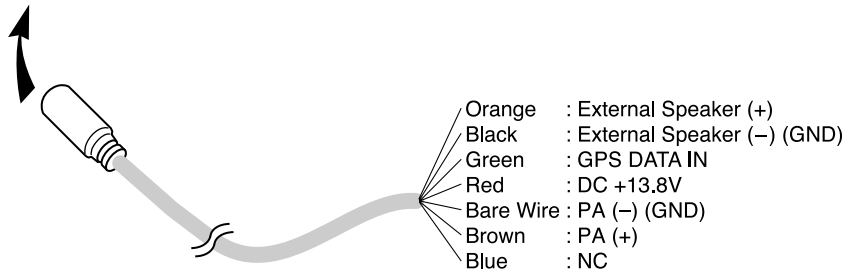

Note: DC13.8V and GND are for GPS ANT.

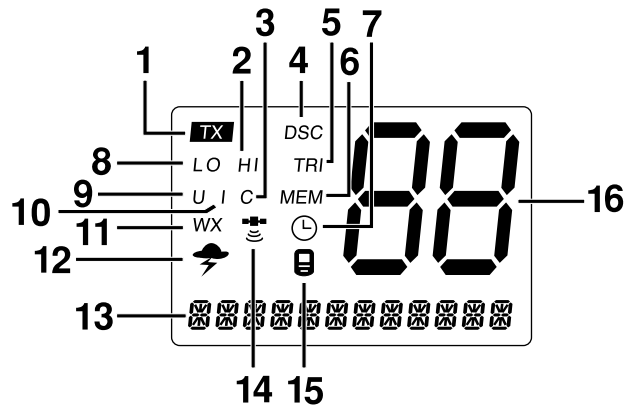

1. **TX** (Transmit) - Indicates transmitting.
2. **HI** (High) - Indicates transmit output is 25 Watts.
3. **C** - Indicates Canadian Channel Mode.
4. **DSC** - Indicates the radio is in the Digital Selective calling mode.
5. **TRI** (Triple Watch) - Indicates Triple Watch Mode is in effect.
6. **MEM** (Memory) - Indicates that the channel is entered into the Scan memory.
7. ⌚ (**Alarm Icon**) - It appears when the alarm clock is set.
8. **LO** (Low) - Indicates transmit output is 1 Watt.
9. **U** - Indicates USA Channel Mode.
10. **I** - Indicates International Channel Mode.
11. **WX** - Indicates Weather Channel Mode has been activated.
12. ⚡ ("**ALT**" **Icon**) - Indicates Weather Alert Mode has been activated.
13. **Radio Status Indicator** - This area is used for Channel Name, Menu, Frequency of active Weather Channel and messages concerning SAME, DSC, and GPS. These messages will continually scroll from right to the left.
14. 📶 (**GPS Icon**) - Indicates the radio is receiving data from an external GPS.
15. 📻 (**WHAM Icon**) - Indicates the radio it is connected to the control unit of the WHAM. (Wireless Handheld Access Microphone)
16. **Channel Display** - Indicates the current Channel Number.



NOTES: "POS SEND", "LOCAL TIME ADJUST", "DAYLITE SAVINGS", and "ALARM CLOCK" are not displayed in Menu when external GPS receiver is not connected.

When the radio is in one of the following modes: WX Alert mode, Channel 16/9 mode, Scan Mode, or Triple Watch mode, and the user presses the Menu key, all the of these modes are cancelled.

The Menu mode will be cancelled if the radio receives a DSC call or any key is pressed besides the Up arrow, Down arrow, or select keys are pressed.

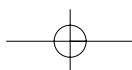
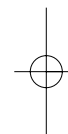
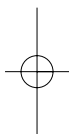

Installation

Caution: *The VHF500 will only operate with a nominal 12 volt negative ground battery system.*

Keep in mind the flexibility designed into the **VHF500** so that you can most conveniently use it. Features which should be considered are:

1. The universal mounting bracket may be installed on either the top or bottom of a shelf, on a bulkhead, or for overhead mounting.
2. The REMOTE speaker wires can be used with an auxiliary speaker.
3. All connections are "plug-in" type for easy removal of the radio.
4. By using the optional WHAM (Wireless Handheld Access Microphone), the VHF 500 can be mounted completely out of the way.
5. Also optionally available is your choice of flush mount brackets (White - 500FMW, Black - 500FMB).

Choosing a Location

Some important factors to consider in selecting the location for your **VHF500**.

1. The **VHF500** is completely waterproof, but will last longer if protected from spray and splash.
2. Keep the battery leads as short as possible. Direct connection to the battery is most desirable. If direct connection can not be made with the supplied power lead, any extension should be made with #12-14 AWG wire. Long extensions should use larger gauge wire.
3. Keep the antenna lead - in wire as short as possible. If you must use a long lead - in wire as in the case of a sailboat masthead antenna installation, we recommend you upgrade your lead - in wire according to the following table:

RG-58	<20'
RG-8X	<35'
RG-8U	<60'
4. Locate your antenna as high as possible and clear from metal objects. The reliable range of coverage is a direct function of the antenna height.
5. Select a location that allows free air flow around the heat sink on the rear of the radio.



6. Select a location well away from the ship's compass. Auxiliary speakers also should be located away from the compass.

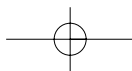
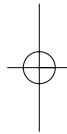
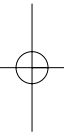

Engine Noise Suppression

Interference from the noise generated by the electrical systems of engines is sometimes a problem with radios. The **VHF500** has been designed to be essentially impervious to ignition noise and alternator noise. However, in some installations it may be necessary to take measures to further reduce the effect of noise interference. The VHF500 radio DC battery wires, antenna lead, and accessory cables should be routed away from the engine and engine compartment, and from power cabling carrying high currents.

In severe cases of noise interference, it may be necessary to install a noise suppression kit. Contact your West Marine store or dealer from whom you purchased the radio for more information.

Antenna Considerations

A variety of antennas are available from a number of quality suppliers. In general, we recommend 8' 6dB rated antennas for powerboats, and 4' 3dB antennas for sailboats.

In general, communication range is increased by using a high-gain antenna placed as high as possible above the water line. Antennas should be located away from metal objects. Keep coax feed cables as short as practical.

Antenna Selection and Installation

VHF500 has been designed to accommodate all of the popular marine VHF antennas. However, the selection and the installation of the antenna is the responsibility of the user or installer.

The FCC has determined that excessive radiation poses a health risk to people near radio transmitting antennas. Therefore, the antenna used with this radio should be installed using the following guidelines to insure a suitable distance between the antenna and persons close by.

Small whip antennas (3 dB) or smaller should be installed keeping at least three feet separation distance between the radiating element and people.

Larger antennas (6 dB or 9 dB) should be installed keeping at least a six foot separation distance.

No person should touch the antenna or come into the separation distance when the radio is transmitting.

Installing the VHF500

After you have carefully considered the various factors affecting your choice of location, position the radio (with the bracket, microphone, power cord, antenna and any auxiliary cables installed) into the selected location to assure there is no interference with the surrounding items. Mark the location of the mounting bracket. Remove the bracket from the radio and use it as a template to mark the holes to be drilled for the mounting hardware. Drill the holes and mount the bracket with hardware compatible with the material of the mounting surface.

Note: *This HEXAGON HEAD BOLT is only for mounting the bracket with hardware. Do not use it for installing the radio in the mounting bracket.*

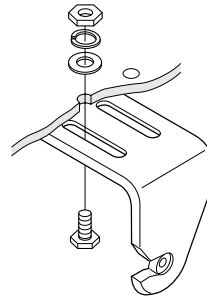

Connect the red wire of the supplied power cord to the positive (+) side of your distribution circuit or battery. Connect the black wire of the supplied power cord to the negative (-) side of your distribution circuit or battery. The power cord is equipped with a fuse to protect the radio. Use only a six (6) ampere fast blow fuse for replacement. Connect the power cord to the keyed connector on the power "pigtail".

Connect the antenna and all other auxiliary cables and accessories. Install the radio in the mounting bracket and connect all cables and accessories to the appropriate jacks and connectors.

Note: *Do not use any other mounting knobs than the ones enclosed. Do not insert the knobs without attaching the bracket.*

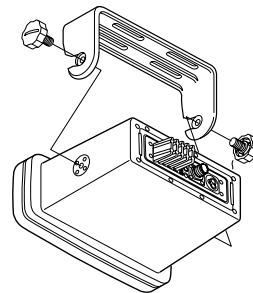

Operation

POWER On/Off

Turn the unit On by rotating the **PWR/VOL** control clockwise. Adjust the volume to a comfortable level.

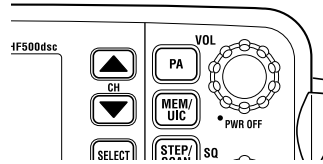

When you turn the unit On, you will hear a beep, and the greeting message below appears on the Radio Status Display for 3 seconds.

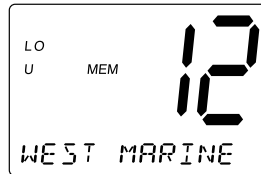

Last Channel Memory

The **VHF500** memorizes the last channel selected before you turn Off the radio. For example, if you turn Off the radio on CH 12, it will be on that channel when turned back On.

Note: *In order for the last channel to be memorized, you must have the radio on that channel for 3 seconds.*

SQUELCH

Turn **SQUELCH** fully clockwise. This raises the “Squelch Gate” so high that only very strong signals can get through.

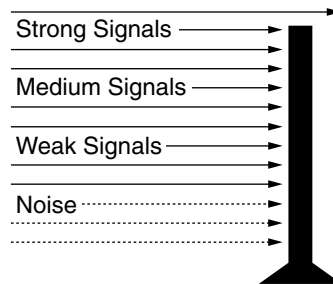
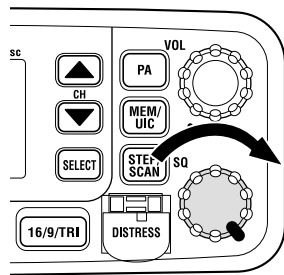

Turn **SQUELCH** fully counterclockwise until you hear a hiss. This lowers the “Squelch Gate” so that everything gets through - noise, weak signals, and strong signals.

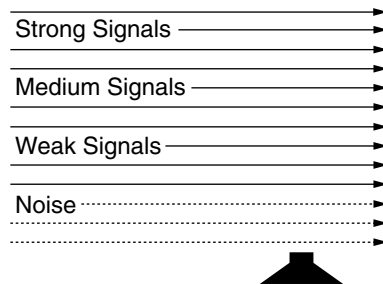
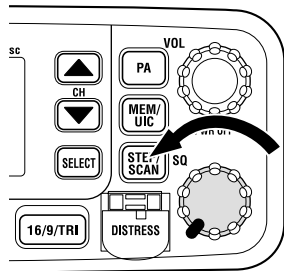

Turn **SQUELCH** back clockwise until the hiss stops. For best results, adjust the squelch so that the noise is eliminated, but no further.

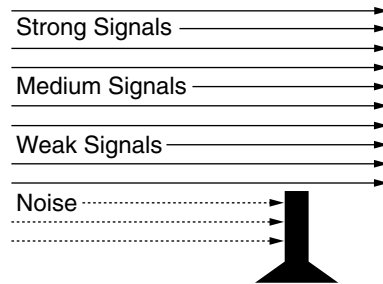
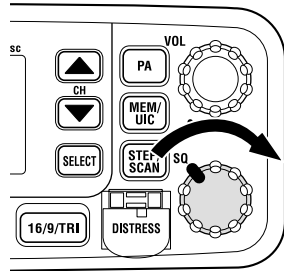

HAILING AND DISTRESS CHANNEL 16/CHANNEL 9 COMMUNICATIONS

To select Channel 16 or Channel 9, press the **16/9/TRI** key. The first press of the **16/9/TRI** key will select the Hailing and Distress channel 16 instantly while tuned to another channel. A second of **16/9/TRI** key will select channel 9. Press **16/9/TRI** briefly a third time to return to the channel selected prior to accessing Hailing and Distress Channel 16/Channel 9 communications. The display will indicate the selected channel.

To cancel Hailing and Distress Channel 16/Channel 9 communications:

- Press **16/9/TRI** briefly until the previous channel setting appears.

--or--

- Press **WX/ALERT**, **CH ▲, ▼** or **STEP/SCAN** briefly.



MARINE DISTRESS PROCEDURE

Speak slowly – clearly – calmly.

1. Make sure your radio is On.
2. Tune to Channel 16.
3. Press the PTT button on the microphone and say: "MAYDAY – MAYDAY – MAYDAY."
4. Give your ship ID.
5. Say "MAYDAY [your ship name]."
6. Give your location: (what navigational aids or landmarks are near).
7. State the nature of your distress.
8. Give the number of persons aboard and the conditions of any injured.
9. Estimate present seaworthiness of your vessel.
10. Give a brief description of your vessel (meters, type, color, hull).
11. Say: "I will be listening on Channel 16".
12. End message by saying "THIS IS [your ship name or call sign] OVER."
13. Release the PTT button and listen. Someone should answer. If not, repeat call, beginning at Item 3 above.

TRIPLE WATCH

Triple Watch monitors Channel 16, Channel 9, and the current Marine Channel (home or normal Channel) or Weather Channel.

To activate Triple Watch, Press **16/9/TRI** for more than two seconds. TRI appears on the Radio Status Display, indicating Triple Watch mode is in effect. If a signal is received on either Channel 16 or Channel 9, the radio remains on that channel until the signal ends.

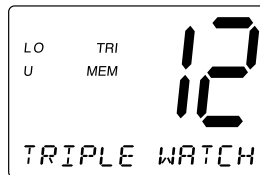

Press **16/9/TRI** for more than two seconds to cancel the Triple Watch mode.

Note: While in Triple Watch mode, you can change the currently selected channel using **CH ▲** and **▼**. A momentary press of the **16/9/TRI** button interrupts Triple Watch mode and remains on channel 16, or on channel 9 if you press **16/9/TRI** briefly once more. To return to the Triple Watch mode, simply press the button briefly again.

SELECTING A CHANNEL

To manually select a channel, press **CH ▲** or **▼** briefly. Communication channels are located on channel 01-28 and 60-88. Weather channels are located on channels WX 0-9.

Note: In the US, the Coast Guard may refer to Channels 21, 22, 23 etc. as 21 alpha, 22 alpha, etc. The VHF500 shows these channels in the USA mode as channel 21, 22, 23, etc.

WEATHER CHANNELS

To select Weather Channels 0-9, press **WX/ALERT** briefly. The radio will go to the last selected Weather Channel. Press **CH ▲** or **▼** briefly to select a different Weather Channel. Most areas of the US are covered by Weather Channels 1,2, and 3.



To exit from Weather Channel:

- Press **WX/ALERT** briefly. The radio returns to the previous Marine channel.

ENTERING CHANNEL NUMBERS INTO MEMORY SCAN

You can enter channels into the radio's memory so they can be rapidly scanned. This means that you can have the radio move from one memorized channel to the next, and have it stop to monitor the channel only if there is traffic, or conversations, on that channel.

To enter a channel into Memory Scan, select the channel you want to store by using **CH ▲** and **▼**, and then press **MEM/UIC** briefly. The channel is stored in Memory Scan and **MEM** appears on the Radio Status Display.

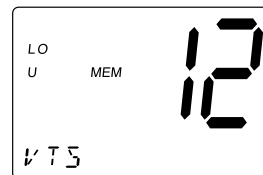

To cancel the channel in Memory, press **MEM/UIC**. The **MEM** icon disappears.

Note: *The Memory channel can be set independently in 3 regional modes (USA, INT, and CAN). You cannot use this feature in WX mode or for channel 70.*

MEMORY CHANNEL SCAN

This feature will allow you to scan only the channels of your choice.

Memory Channel Scan can only be activated if channels have previously been placed into memory.

To turn on Memory Channel Scan, press and hold the **STEP/SCAN** key for 2 seconds.

The VHF500 will now scan the channels that were previously placed into memory, starting with the lowest channel number to the highest channel number.

TRIPLE WATCH ALERT SCAN

This feature will allow you to listen to the channel of your choice. Scan channels 16 and 9 every 2 seconds, and scan for Emergency or Weather Alerts every seven seconds to be sure that you will not miss any important broadcasts.

To turn Triple Watch Alert Scan On, press and hold **WX/ALERT** for 2 seconds while in Memory Channel Scan mode. While the Memory Channels are scanned, Channel 16 and Channel 9 are scanned every 2 seconds, and the Weather Channel is scanned every 7 seconds. **TRI** and  icon appear on the Radio Status Display.

ALERT SCAN

This feature will allow you to scan the channels of your choice and also scan the Weather channels for Emergency or Weather alerts.

To turn Alert Scan On, press and hold **WX/ALERT** for 2 seconds. While Memory Channels are scanned, the Weather Channel is scanned every 7 seconds. The  icon appears on the Radio Status Display.

WEATHER ALERT

Weather Alert is a safety function that allows the radio to monitor the local weather channel for NOAA Weather Alert broadcasts, while allowing you to listen to other channels.

The traditional weather feature receives weather broadcasts (usually within a 50-mile radius) then sounds an alarm if the emergency tone is transmitted. This means that people who live outside an affected area are often alerted even when their area is not affected, causing many of them to ignore potentially real emergency/weather warnings that can save lives.

ABOUT S.A.M.E. WEATHER ALERT

In 1994, the National Oceanic and Atmospheric Administration (NOAA) began broadcasting coded signals called FIPS (Federal Information Processing System) codes along with their standard weather broadcasts. These codes identify an emergency and the specific geographic area (such as a county) affected by the emergency.

The **VHF500** was developed with the SAME (Specific Area Message Encoding) technology. This allows your radio to receive, interpret, and display the information about the codes so you can determine if the emergency might affect your area.

Each FIPS code identifies a specific geographic area (defined by the National Weather Service), so your radio sounds an alert only when an emergency/weather emergency is declared in those locations. This helps you more efficiently track the emergency/weather conditions in and around your area.

When the VHF500 receives a weather alert:

- It sounds an alert siren.
- A description of the alert appears.

The alert descriptions your radio can display are based on a list of specific weather alert types published by the NWS (National Weather Service). For a list of all the alert descriptions that your radio can display. Please see the NWR-SAME EVENT CODE section of this manual.

Caution: *The NWS uses sophisticated weather models to determine an alert's effective time. However, the end of an alert does not necessarily mean that the related weather emergency is over.*

The Weather Alert mode can be activated to alert you of dangerous weather. When Weather Alert is turned On, and a warning signal is received, an emergency siren will sound at full volume, regardless of the volume setting. When the signal stops, you will hear the active weather channel broadcast at the normal volume setting.

Note: See *SETUP* mode to program up to 10 FIPS codes.

The  icon indicates the Weather Alert mode is activated. To activate the Weather Alert mode:

1. Press **WX/ALERT** for more than two seconds when WX ALERT is Off. The radio turns the WX ALERT On and the  icon appears.



2. If the radio receives a 1050Hz tone, the  icon will blink every other second and the alert tone will ring. In the area where SAME is broadcasted, the following is displayed.



3. When a WX ALERT signal is received, all other functions are canceled and the radio remains on the selected weather channel. When the radio is in Scan mode, scanning the weather channel every 7 seconds, the SAME signal is not decoded. To decode the SAME signal, the radio should be on an active weather channel. In order to stop the alert press any key briefly. If you press any key briefly once more, the alert icon disappears.



Note: The radio must be tuned to an active weather channel to decode the SAME signal. This is necessary because the SAME signal is only broadcast in the very beginning of the 10 second Weather alert tone by National Weather Service.

SETTING THE TRANSMIT (TX) POWER

The **VHF500** transmits on fifty-four marine frequencies and receives on eighty marine frequencies. Channel 70 of the USA, International, and Canadian frequencies, channel 15 of the USA frequencies, and Weather Channels 0 - 9 – are for receiving only. The radio transmits on channel 70 when sending DSC information. Your radio will not transmit on these channels. For your reference, a listing of all the available marine channels are located on pages 63 - 65.

Caution: *It is important to remember to use the LO position in port or for short range communications.*

1. When you turn the radio On for the first time, the unit is automatically set to transmit at 25 watts (HI).

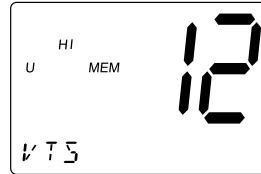

2. Press **H/L/MENU** briefly to change the transmit output power to 1 watt (LO).

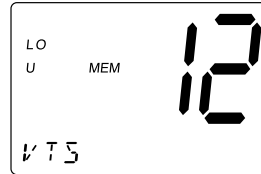

3. Press **H/L/MENU** briefly again to change back to 25 watts (HI).

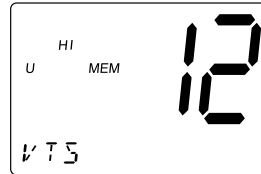

Note: *A short tone sounds everytime you press the **H/L/MENU**. CH13 is 1 watt (LO) channel. When the channel is LO power channel, you can transmit at 25 watts (HI) by pressing **H/L/MENU** during the call. LO power channels are USA Channels 13, 17, 67, 77; Canadian Channels 13,15,17,20,66,70; INT Channel 15,17. Use low transmit power in harbors or when close to the receiving station. You can not change the transmit power setting on channels which are receive-only channels: all weather channels; USA Channels 15, 70; Canadian Channel 70; International Channel 70.*

Menu Operation

Flow Chart for Menu Operation

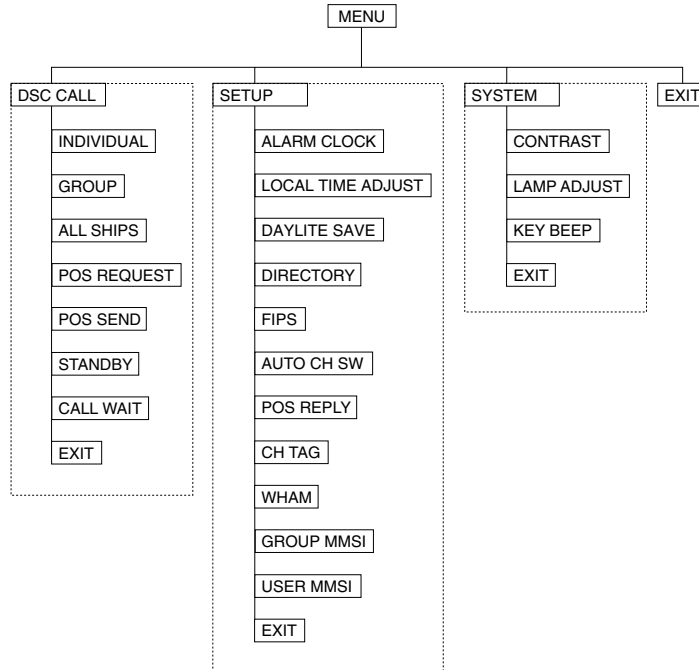

The VHF500 includes the following DSC features:

INDIVIDUAL CALL - Quickly call other boats from your calling directory.

GROUP CALL - Easily call a group of boats.

ALL SHIPS CALL - Allows you to send Urgent, Safety related, or Routine calls to all ships in your area.

POSITION REQUEST - Easily request the position of a boat in your call directory.

POSITION SEND - The ability to send your position information to a boat in your call directory.

STANDBY - This allow your radio to acknowledge calls with "Unavailable" while you are away from your boat.

CALL WAITING - Your VHF500 will automatically log into a directory incoming calls for you to review at a later time if you are not available to take the call immediately.

1. DIGITAL SELECTIVE CALLING (DSC)

Digital Selective Calling is the latest in Marine Radio technology. DSC is a process of establishing a radio call and has been chosen by the International Maritime Organization (IMO) as an international standard for establishing VHF, MF and HF radio calls. Digital Selective Calling has also been selected as part of the Global Maritime Distress and Safety System (GMDSS).

This service will let you instantly send a Distress call with GPS position (when optional GPS receiver is connected to the **VHF500**) to the US Coast Guard and other vessels within range of the transmission.

DSC will also let you initiate or receive distress, urgency, safety, position information and routine calls to or from another vessel outfitted with a DSC transceiver.

See the directory section for instructions on how to setup the directory of names.

Note: • Position *SEND* and *ALARM CLOCK* will not be displayed if GPS is not connected.

DISTRESS

Note: You must set the user MMSI in order to send a Distress call. Please see page 57 to set the MMSI.



This feature will allow you to transmit a Distress call.

1. In order to transmit a Distress call, press **DISTRESS** for more than 5 seconds.

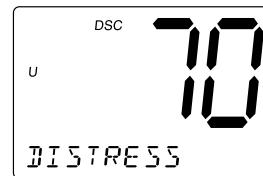

- The Distress call is transmitted and it waits for about 210 - 270 seconds for an acknowledgement from the Coast Guard before the Distress call is resent. After the Distress call has been sent, the Distress alert will sound every other second. The radio will automatically change to channel 16, and it also watches channel 70 in the background until an acknowledgement signal is received from the Coast Guard shore station.

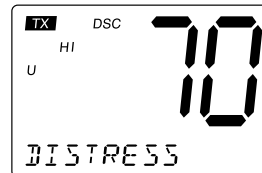

To cancel the Distress call, press **16/9/TRI** briefly.

Note: Only the Coast Guard can electronically acknowledge a Distress call.

- When the radio receives a Distress call, the following screen appears. If an acknowledgment is not received, the Distress call is repeated until an acknowledgment is received from the Coast Guard shore station.

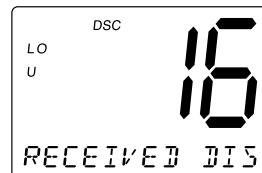
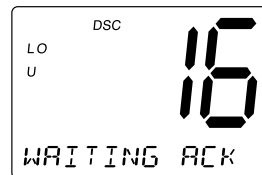

Note: If the radio receives a Distress call, it will be displayed on the Radio Status Display. An emergency alert will sound. The name will be displayed if it is the name registered in the directory. Otherwise, sender's MMSI is displayed. Latitude, longitude, and time information will also be displayed if the GPS receiver is carried in the vessel that transmitted a DSC Distress call.

To enter the MENU:

- Press **H/L/MENU** for more than two seconds to enter the Menu Operation.

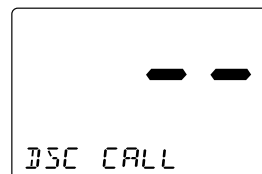

- Press **SELECT** briefly to enter DSC CALL.

DSC CALL has 7 options as follows:

To exit, select EXIT.

1-A. INDIVIDUAL CALL

This feature allows the user to contact another boat and to automatically switch the receiving DSC radio to desired channel.

1. First you must select an open channel.
2. Press **SELECT** briefly at DSC CALL.

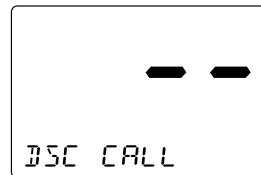

3. **INDIVIDUAL** appears. Press **SELECT** briefly.

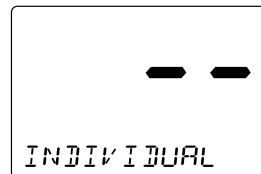

4. Select the individual you want to contact using **CH ▲** and **▼**. Press **SELECT** briefly to transmit the individual DSC signal.

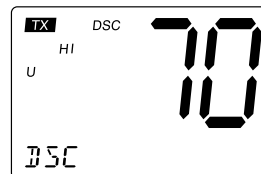

5. **WAITING** appears followed by the individual you have selected, and the radio use Channel 70 while transmitting.

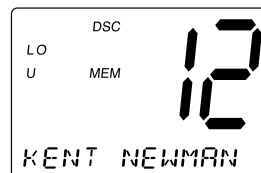

6. When you receive the individual acknowledgment successfully, **WAITING** will change to **COMPLETED**. Both radios tune to the selected channel. (example: choose channel 68, then make the call, when the call is successful both radios will be on channel 68. You are now ready to talk to the other person on this channel.)

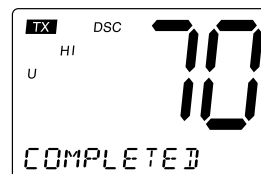

Note: *If there is not any data registered in the directory you cannot proceed to the 2nd step. See the SETUP section for directory, setup instructions.
Select an open (unused) working channel first, then make the call. After the acknowledgment, both radios tune to the previously selected channel.*

1-B. GROUP CALL

This function allows the user to contact a group of specific vessels using DSC and to automatically switch to a desired channel. This function allows you to transmit a DSC signal with group MMSI.

1. First you must select an open channel.
2. Press **SELECT** briefly at DSC CALL (To enter DSC CALL, see page 26). INDIVIDUAL appears.

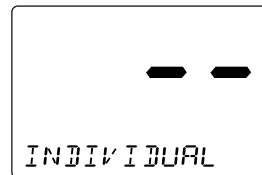

3. Press **CH ▼** briefly once to select GROUP.

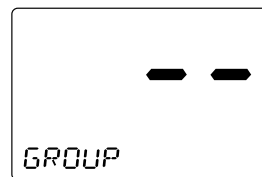

4. Press **SELECT** briefly. The MMSI code appears, and you can now call the group members. Press **SELECT** briefly to call. When you finish calling, the radio returns to the channel display screen.

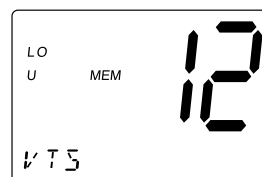
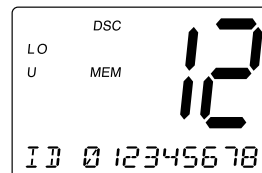

1-C. ALL SHIPS CALL

This radio has the ability to send 3 types of all ships calls. The following are examples of what these types of calls would be used for:

Urgency - This call is for a vessel not yet in Distress, but may have a serious problem.

Safety - This call is used for a reason like debris in the Water.

Routine - This call is used for normal calls.

1. Press **SELECT** briefly at DSC CALL (To enter DSC CALL, see page 26). INDIVIDUAL appears.

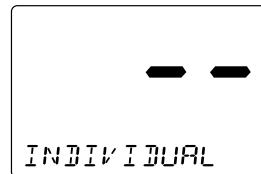

2. Press **CH** ▼ twice to select ALL SHIPS.

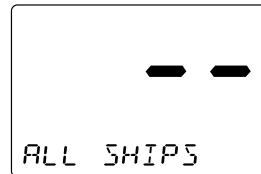

3. Press **SELECT** briefly. URGENCY appears.

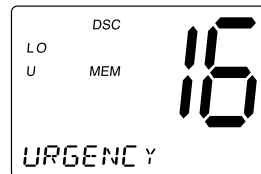

4. Select the category of your call using **CH** ▲ and ▼ (URGENCY, SAFETY, ROUTINE).

Note: ROUTINE calls tune to the previously selected channel. URGENCY and SAFTY calls tune to channel 16.

5. Press **SELECT** briefly to transmit the ALL SHIPS DSC signal.
When sending either an **URGENCY** or **SAFETY** message, all radios will automatically move to channel 70 until all of the data is received.

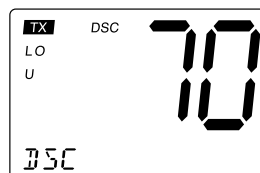

6. After selecting **URGENCY** or **SAFETY** ALL SHIPS call is transmitted, the radio will switch to Channel 16. You should wait a few minutes before transmitting the ALL SHIPS call information.

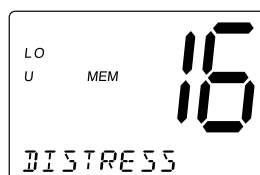

1-D. POSITION REQUEST

This radio has the ability to request the position of an individual vessel that is registered in the DIRECTORY.

1. Press **SELECT** briefly at DSC CALL (To enter DSC CALL, see page 26). INDIVIDUAL appears.

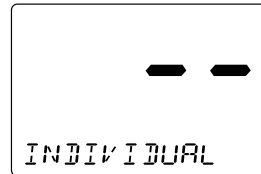

2. Press **CH** ▼ three times to select POS REQUEST.

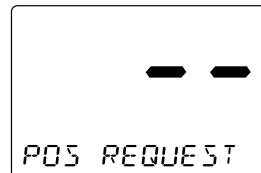

3. Press **SELECT** briefly. The individual directory appears.

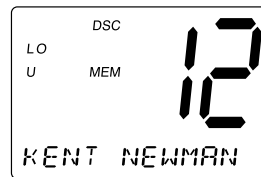

4. Select the name to request the individual's position using **CH** ▲ and ▼.

5. Press **SELECT** briefly to transmit the position request call. POS WAITING appears followed by the individual, and the radio use 70 CH while transmitting.

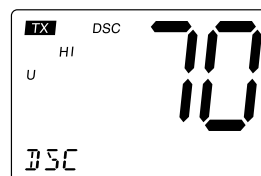

6. When the called vessel sends the position information, time and position appears followed by the individual. You can see the time and the position.

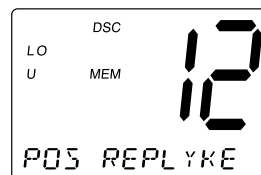

Note: The requested radio must have the ability to transmit the position information (such as having a VHF500 radio).

1-E. POSITION SEND

This radio has the ability to send the position of your vessel to another vessel using a VHF marine radio equipped with DSC.

Note: Position send is only available when it is connected to the GPS.

1. Press **SELECT** briefly at DSC CALL (To enter DSC CALL, see page 26). INDIVIDUAL appears.

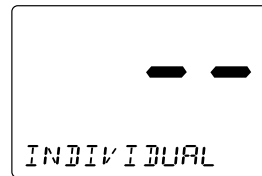

2. Press **CH** ▼ four times to select POS SEND.

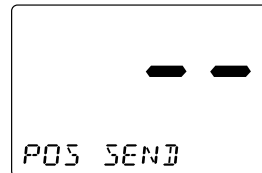

3. Press **SELECT** briefly. The individual directory appears.

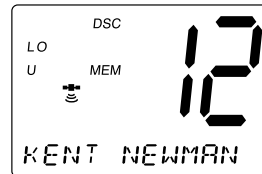

4. Press **SELECT** briefly to send your position information.

5. The following screen appears.

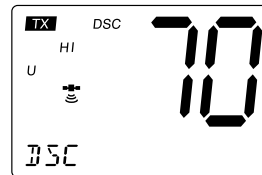

1-F. STANDBY

The DSC STANDBY function allows the VHF500 to answer DSC calls with the UNATTENDED message and record the calls for response at another time. When you set the radio to DSC STANDBY mode, voice traffic may still be active on any chosen channel.

1. Press **SELECT** briefly at DSC CALL (To enter DSC CALL, see page 26). INDIVIDUAL appears.

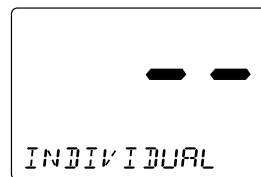

2. Press **CH ▼** five times to select STANDBY. Then times to select briefly.

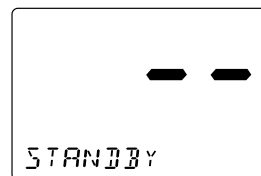

3. When an individual DSC call is received, the radio will respond with the UNATTENDED message when an operator cannot answer the call. The DSC call will be recorded into the radio's Call Waiting directory.

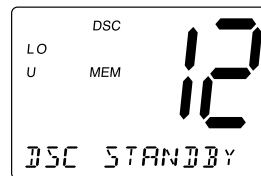

Note: If you press a key on the radio or the PTT, this feature will be canceled.

1-G. CALL WAIT

The DSC Call Waiting directory records 10 received distress calls, and records 20 individual calls that are received and not answered within 5 minutes or while the radio is set to DSC Standby. Calls will be recorded while you are busy with other communications as long as the transmitter is not keyed at the time of the call. If the call is answered within 5 minutes the call will not be recorded. When a call is recorded, a message appears.

1. Press **SELECT** briefly at DSC CALL (To enter DSC CALL, see page 26). INDIVIDUAL appears.

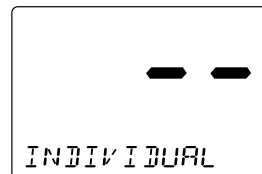

2. Press **CH** ▼ repeatedly to select CALL WAIT.

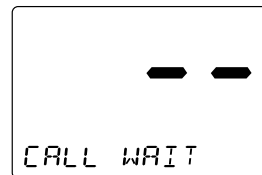

3. Press **SELECT** briefly. The CALL WAIT directory appears.

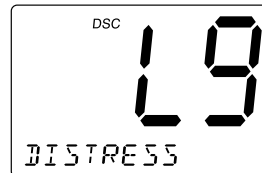

4. Select the options you want to view using **CH** ▲ and ▼.

Note: If a call has not been logged, the radio will beep and you will not be able to proceed to the next step.

5. Press **SELECT** briefly.

6. If a DISTRESS call is received in Call Wait, the following display appears.

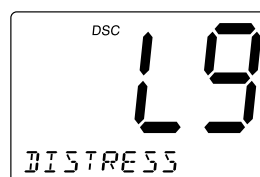

If an INDIVIDUAL call is received in Call Wait, the following display appears. At this point, you can call back any of the radios in the log.

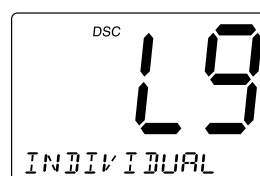

7. Press **SELECT** briefly. Received data appears.

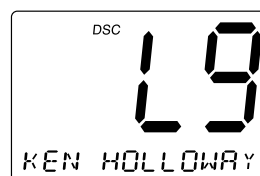

8. Using CH ▲ and ▼ allows you to look through all of the data. If you press **SELECT** briefly, the radio starts transmitting.

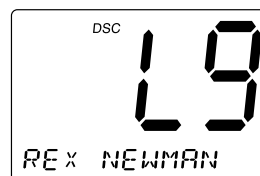

2. SETUP

1. Press **H/L/MENU** for more than two seconds to enter Menu Operation.
2. Press **CH ▼** once to display **SETUP**, and press **SELECT** briefly.



SETUP has 9 options as follows. To exit, select EXIT.

2-A. ALARM CLOCK

This feature is only available when the GPS is connected to the NMEA0183 Accessory Wires. If it is connected to the GPS, the alarms are set based on the satellite. You need to set the time previously to setting the alarm.

2-A-1. ALARM SET

This feature allows you to set the alarm.

1. Press **SELECT** briefly at **SETUP**. **ALARM CLOCK** appears.
2. Press **SELECT** briefly.
3. Press **CH ▲** or **▼** to select On. Then, press **SELECT** for more than two seconds
4. Select the hour using **CH ▲** and **▼**, then press **SELECT** briefly.
5. Select the minute using **CH ▲** and **▼**, then press **SELECT** briefly.

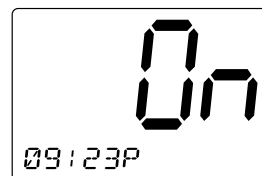
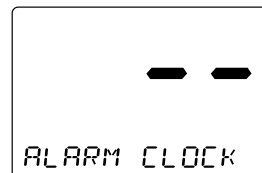

6. Select AM or PM using **CH ▲** or **▼**, then press **SELECT** briefly.

7. A confirmation screen appears.

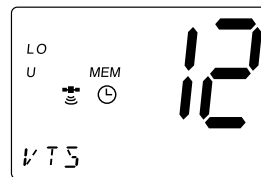

2-A-2. ALARM ON

This feature allows you to turn the alarm ON.

1. Press **SELECT** briefly at **SETUP** (To enter **SETUP**, see page 36).



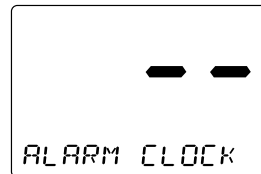

2. **ALARM CLOCK** appears. Then, press **SELECT** briefly.

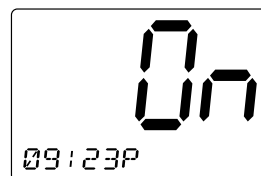

3. Press **SELECT** briefly again.

4. Select **On**. Using **CH ▲** or **▼**, and press **SELECT** briefly. The radio returns to the channel display screen and the  icon appears.



5. When the radio reaches the set time the alarm sounds and the  icon blinks.

Note: *The alarm sounds when the set time is reached, you can turn the alarm Off by pressing any key. Alarm mode will turn Off automatically once the alarm sounds.*

2-A-3. ALARM OFF

This feature allows you to turn the alarm OFF.

1. Press **SELECT** briefly at **SETUP**
(To enter **SETUP**, see page 36).

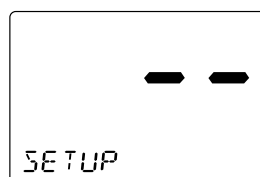

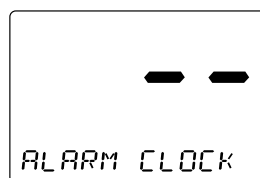

2. **ALARM CLOCK** appears.

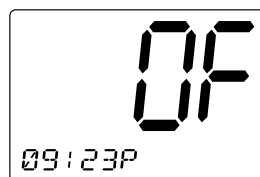

3. Press **SELECT** briefly.

4. Select **OF** using **CH ▲** or **▼**, then press **SELECT** briefly.



5. Press **SELECT** briefly. The radio returns to the channel display screen and the  icon disappears.

2-B. LOCAL TIME ADJUST

This feature allows you to fine tune the Local Time for any location in North America. The feature enables you to adjust the Local time by ± 1 hour.

To set LOCAL TIME ADJUST

1. Press **SELECT** briefly at **SETUP**
(To enter **SETUP**, see page 36).



2. Display **LOCAL TIME ADJUST** using **CH▲** and **CH▼**.

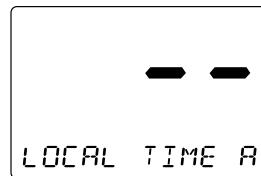

3. Press **SELECT** briefly. The registering screen appears. You can now adjust the time for your local area using **CH▲** and **CH▼**.

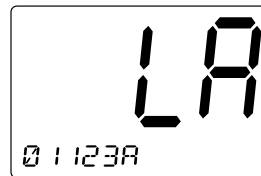

4. The time will be entered when you press **SELECT** briefly. The display returns to **LOCAL TIME ADJUST** screen.

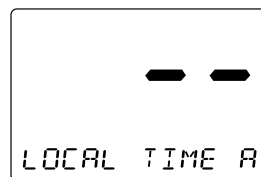

2-C. DAYLIGHT SAVINGS On/Off

This feature enables you to select the automatic Daylight Savings clock setting.

To set DAYLIGHT SAVINGS On/Off

1. Press **SELECT** briefly at **SETUP** (To enter **SETUP**, see page 36).



2. Display **DAYLITE SAVE** using **CH▲** and **CH▼**.



3. Press **SELECT** briefly. Then press **CH▲** briefly to set DAYLIGHT SAVINGS on or **CH▼** to off (the default setting is off).



4. Press **SELECT** briefly. The display returns to **DAYLITE SAVE** screen.



2-D. DIRECTORY

This function will allow you to send an individual call, etc. The Directory function memorizes the name and MMSI number of 20 other vessels. The following screen will allow you to setup an alphanumeric identity as well as the corresponding MMSI number.

1. Press **SELECT** briefly at **SETUP**
(To enter **SETUP**, see page 36).

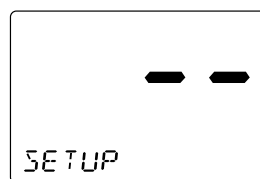

2. Display **DIRECTORY** using **CH ▲** and **▼**.

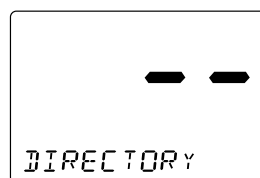

3. Press **SELECT** briefly. The **DIRECTORY** menu appears. Use **CH ▲** and **▼** to select the menu.

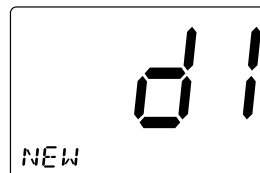

2-D-1. NEW

This function will allow you to enter new information into the directory.

1. Press **SELECT** briefly at **NEW**. The registering screen appears.

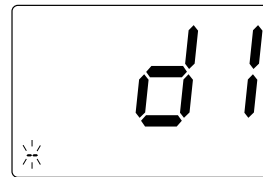

2. You can now enter the person's name. Press **CH ▲** repeatedly to choose the alphabet. The character will be entered when **SELECT** is pressed briefly, and the blinking digit moves to the right.

3. After you enter the person's name, you can enter their MMSI number. Press **CH ▲** briefly to increase the number, **CH ▼** to decrease. The number will be entered when **SELECT** is pressed briefly, and the blinking digit will move to the right.

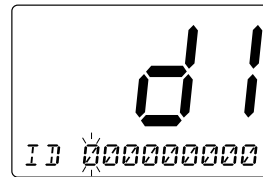

4. When you finish entering the last digit, the radio returns to **NEW** screen.

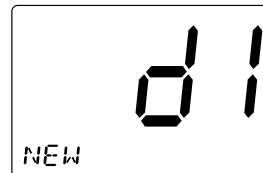

2-D-2. EDIT
If you want to edit the DIRECTORY

1. Press **SELECT** briefly at the individual you want to edit.

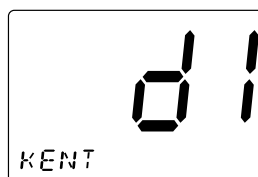

2. **EDIT** appears, then press **SELECT** briefly.

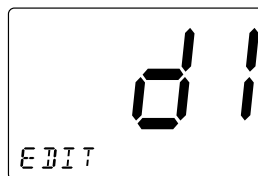

3. You can now edit the person's name. Press **CH ▲** repeatedly, and press **SELECT** briefly to choose the alphabet.

4. After you edit the person's name, you can edit the MMSI. Press **CH ▲** to increase the number, **CH ▼** to decrease. The number will be entered when **SELECT** is pressed briefly and the blinking digit moves to the right.

5. After the directory data is edited, the individual appears.

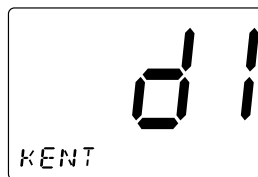

2-D-3. DELETE

If you want to delete the directory

1. Press **SELECT** briefly at the individual you want to delete.

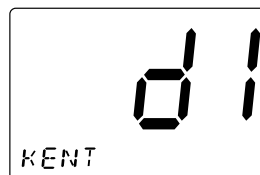

2. Press **CH ▼** once. DELETE appears, then press **SELECT** briefly.



3. The radio displays the next individual. If no more code remains, EXIT appears.

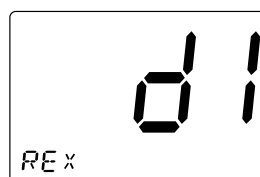

2-E. FIPS

The 6-digit Federal Information Processing System (FIPS) code established by the National Weather Service (NWS) identifies geographic areas in the United States. Programming FIPS codes are necessary to receive SAME alerts about weather occurring in a particular area. To obtain the FIPS code for a particular area contact the NWS toll free at 1-888-NWR-SAME (1-888-697-7263). Or visit their website: <http://www.nws.noaa.gov/nwr/indexnw.htm>. A list of event codes are located on page 66.

To set FIPS code

1. Press **SELECT** briefly at **SETUP**
(To enter **SETUP**, see page 36).

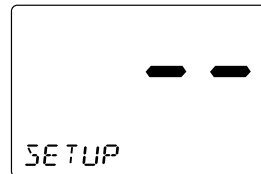

2. Display **FIPS** using **CH ▲** and **▼**.

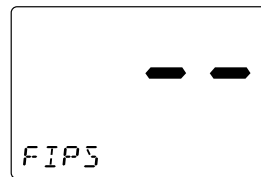

3. Press **SELECT** briefly. The **FIPS** menu appears. Use **CH ▲** and **▼** to select the menu.

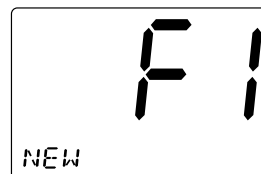

2-E-1. NEW

If you want to register a new FIPS code

1. Press **SELECT** briefly at **NEW**. The registering screen appears.

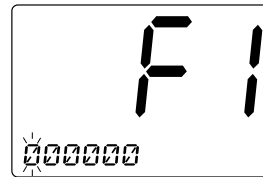

2. You can now enter the new FIPS code. Press **CH ▲** to increase the number, **CH ▼** to decrease. The number will be entered when **SELECT** is pressed briefly, and the blinking digit moves to the right. When you finish entering the last digit, the radio returns to **NEW** screen.

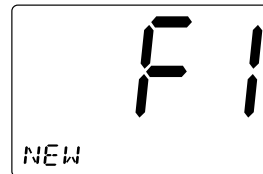

2-E-2. EDIT

If you want to edit the FIPS code

1. Press **SELECT** briefly at the code that you want to edit.

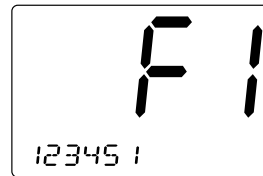

2. **EDIT** appears, then press **SELECT** briefly.

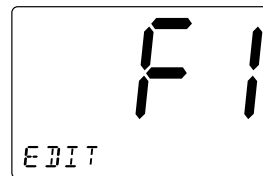

3. You can now edit the FIPS code. Press **CH ▲** increase the number, **CH ▼** to decrease. The number will be entered when **SELECT** is pressed briefly, and the blinking digit moves to the right.

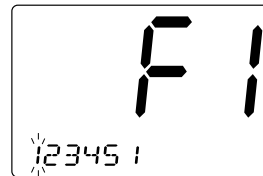

4. When you finished editing the last digit, the confirmation screen appears.

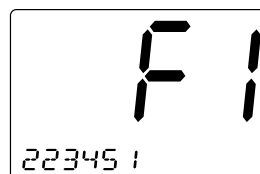

2-E-3. DELETE

If you want to delete a directory entry

1. Press **SELECT** briefly at the code that you want to delete.

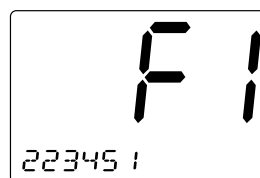

2. Press **CH ▼** once. **DELETE** appears, then press **SELECT** briefly.

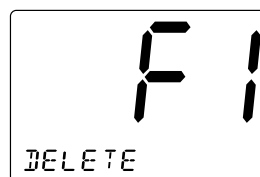

3. The radio displays the next code. If no more code remains, **EXIT** appears.

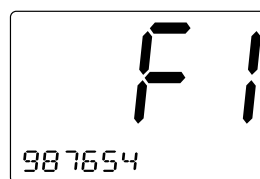

2-F. AUTO CHANNEL SWITCH

This feature is to allow you to disable the automatic channel change that happens when receiving a DSC call. This feature is useful when engaged in bridge – to – bridge or other safety related calls. When you have completed these calls, all of the incoming DSC calls received are available in the call log.

1. Press **SELECT** briefly at **SETUP** (To enter **SETUP**, see page 36).



2. Display **AUTO CH SW** using **CH ▲** and **▼**.

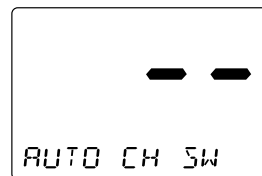

3. Press **SELECT** briefly to enter the setting mode.

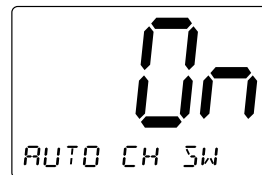

4. If you want to change this mode to off, press **CH ▼** once. (Default is set as ON.)

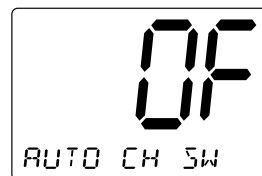

5. Press **SELECT** briefly. The radio returns to the **AUTO CH SW** screen.

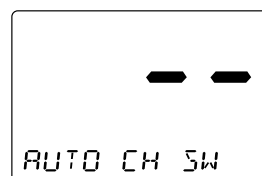

2-G. POSITION REPLY

When the calling radio has requested the position information of your radio, you can decide to transmit an acknowledgment automatically or on a call by call basis.

1. Press **SELECT** briefly at **SETUP** (To enter **SETUP**, see page 36).



2. Display **POS REPLY** using **CH ▲** and **▼**.

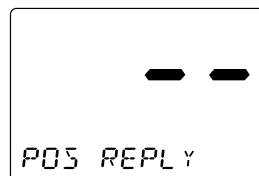

3. Press **SELECT** briefly to enter the setting mode.



4. Press **CH ▲** or **▼** to make your selection.

Example: On
When the radio receives a position request, the following screen appears.



Example: OF
When the radio receives a position request, the following screen appears. You can select whether reply the request or not. If you wants to reply press **SELECT** briefly.

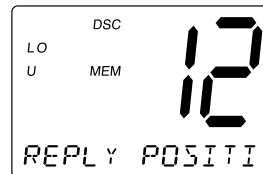

5. Press **SELECT** briefly. The radio returns to the POS REPLY screen.



2-H. CHANNEL NAME

This feature allows you to name each marine channel.

1. Press **SELECT** briefly at **SETUP** (To enter **SETUP**, see page 36).

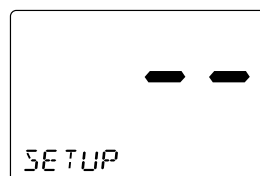

2. Display **CH TAG** using **CH ▲** and **▼**.

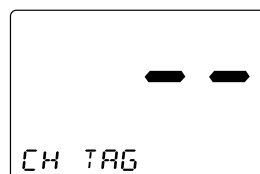

3. Press **SELECT** briefly. The channels and its names appear.

4. Press **CH ▲** and **▼** repeatedly to select the channel that you would like to **EDIT**.

Note: *The VHF500 radio comes pre-programmed with default channel names.*

2-H-1. EDIT

If you want to edit the channel name

1. Press **SELECT** briefly at the individual channel you want to edit. **EDIT** appears.

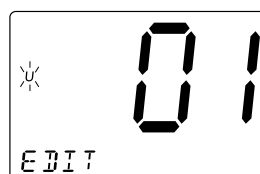

2. Press **SELECT** briefly.



3. You can now edit the channel name. Press **CH ▲** or **▼** to select the alphabet, numeric or symbols. The character will be entered when **SELECT** is pressed briefly, and the blinking digit moves to the right.



4. Press **SELECT** for more than two seconds when you enter the last digit.



2-H-2. DEFAULT

If you want to default the channel name

1. Press **SELECT** briefly at the individual channel you want to edit.

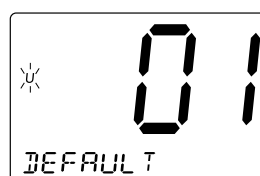

2. Press **CH ▼** once. **DEFAULT** appears.

3. Press **SELECT** briefly. The selected channel name is set as the default.



2-I. WHAM (Wireless Handheld Access Microphone)

This feature, from the setup menu, will allow you to connect the **WHAM**.

Note: When you use the **WHAM** in addition to the **VHF500** wired mic, please set the **BASE ID** for the **WHAM** the same as your **VHF500**. (Please refer to the Owner's Manual for the **WHAM**).

1. Press **SELECT** briefly at **SETUP** (To enter **SETUP**, see page 36).



2. Display **WHAM** using **CH ▲** and **▼**.

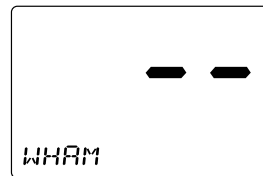

3. Press **SELECT** briefly. **BASE ID** appears.

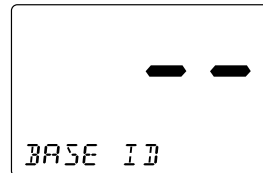

2-I-1. BASE ID

This number consist of 4 digits that you decide yourself. This feature allows you to set the Base ID. To use the **WHAM**, you must set the same Base ID for your **VHF500** and **WHAM**, which enables your **VHF500** and **WHAM** to communicate with one another.

1. Press **SELECT** at **BASE ID**, the following screen appears.

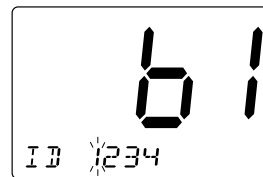

2. Press **CH ▲** to increase the number, **CH ▼** to decrease. The number will be entered when **SELECT** is pressed, and the blinking digit moves to the right. (You can select the number 0000 to 9999.)

3. Press **SELECT** for more than two seconds to enter the last digit. The radio returns to the **BASE ID** screen.

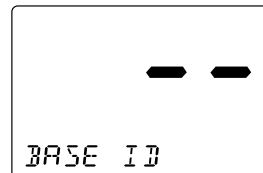

2-I-2. LINK CH

This feature allows you to change the channel between your **VHF500** and the **WHAM** if you encounter interference.

1. Press **CH ▼** once at **BASE ID**.
LINK CH appears.

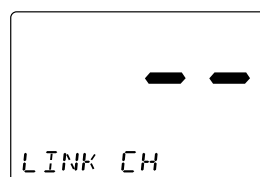

2. Press **SELECT** briefly to enter the editing mode.

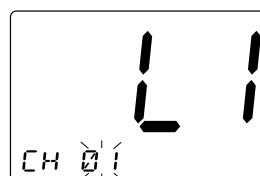

3. Press **CH ▲** to increase the number, **CH ▼** to decrease. The number will be entered when **SELECT** is pressed briefly.

4. The radio returns to the **LINK CH** screen.

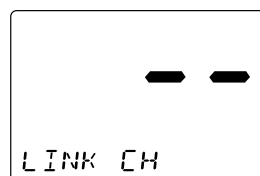

Note: You can select the channel 01-20.

2-J. GROUP MMSI

Group MMSI is the Group ID to contact a group of specific vessels using DSC and to automatically switch to a desired channel. This function allows you to transmit a DSC signal with group MMSI.

1. Press **SELECT** briefly at **SETUP** (To enter **SETUP**, see page 36).

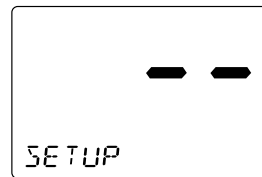

2. Display **GROUP MMSI** using **CH ▲** and **▼**.



3. Press **SELECT** briefly. The group MMSI ID screen appears.

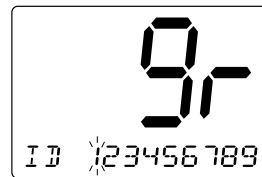

4. You can now enter the **GROUP MMSI** code. Press **CH ▲** to increase the number, **CH ▼** to decrease. The number will be entered when **SELECT** is pressed briefly, and the blinking digit moves to the right.

5. After the final digit is entered, a confirmation screen appears. Press **SELECT** briefly and the radio returns to the following screen.

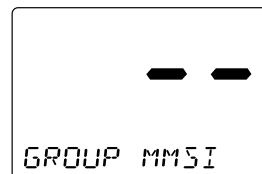

2-K. USER MMSI

Federal MMSI's are issued by the National Telecommunications and Information Administration. Non-Federal MMSI's are issued by the Federal Communications Commission (FCC). You will need to obtain a nine digit MMSI number and program it into the **VHF500**. The information obtained from the application is useful to the U.S. Coast Guard to help in search and rescue operations. To obtain an MMSI number, contact your authorized West Marine store or dealer from whom you purchased the radio or visit one of the following websites: www.boatus.com/mmsi/, <http://wireless.fcc.gov/marine/fctsh14.html>.

This portion of the SETUP menu will allow you to program an MMSI, (Maritime Mobile Service Identity) for sending and receiving DSC calls.

To set USER MMSI code

1. Press **SELECT** briefly knob at SETUP.

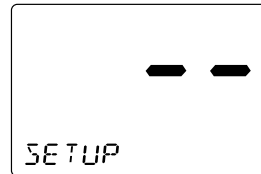

2. Press **CH ▼** eight times to select USER MMSI.

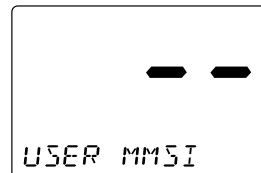

3. Press **SELECT** briefly. The user MMSI ID screen appears.

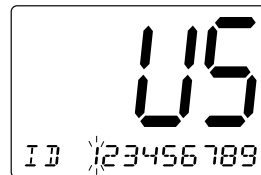

4. You can now enter the USER MMSI code. Press **CH ▲** to increase the number, **CH ▼** to decrease. The number will be entered when **SELECT** is pressed briefly, and the blinking moves to the right.
5. After the final digit is entered. Press **SELECT** for more than two seconds. The radio returns to USER MMSI screen.

Note: *You can only program your radio twice with an MMSI number. After that, send your radio to West Marine for factory service.*

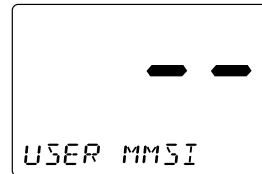

3. SYSTEM

1. Press **H/L/MENU** for more than two seconds to enter Menu Operation.
2. Press **CH ▼** twice to display **SYSTEM**, and press **SELECT** briefly.

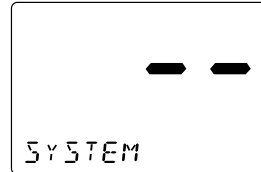

SYSTEM has 3 options as follows. To exit, select **EXIT**.

3-A. CONTRAST

1. Press **SELECT** briefly at **SYSTEM**. **CONTRAST** appears.
2. Press **SELECT** briefly to enter the setting mode. (Default is set at 7).
3. Press **CH ▲** and **▼** to increase or decrease the contrast level.
4. When you find the most favorable contrast, press **SELECT** briefly. The radio returns to the **CONTRAST** screen. If you want to exit the setting screen without changing the contrast, press **H/L/MENU** briefly.

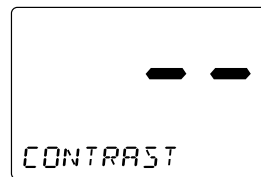
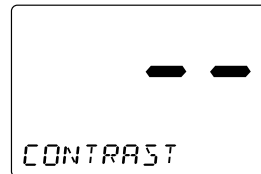

Note: There are 40 contrast levels (0 - 7).

3-B. LAMP ADJUST

1. Press **SELECT** briefly at SYSTEM.
(To enter SYSTEM, see page 59.)

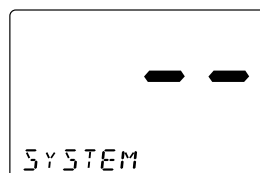

2. Press **CH** ▼ once to select LAMP ADJUST.



3. Press **SELECT** briefly to enter the setting mode. (Default is set at 3).



4. Press **CH** ▲ and ▼ briefly to select the backlight brightness level.

5. When you find the most favorable brightness, press the **SELECT** briefly. The radio returns to the LAMP ADJUST screen.

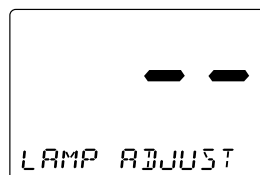

Note: The backlight settings are off, Level 1 Dim, Level 2 medium, and Level 3 bright.

3-C. KEY BEEP

1. Press **SELECT** briefly at SYSTEM.
(To enter SYSTEM, see page 59.)

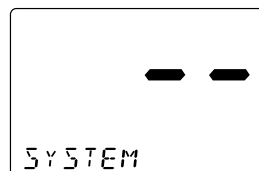

2. Press **CH** ▼ twice to select KEY BEEP.



3. Press **SELECT** briefly to enter the setting mode.



4. Press **CH** ▲ and ▼ briefly to select ON or OFF.

5. Press **SELECT** briefly. The radio returns to the KEY BEEP screen.

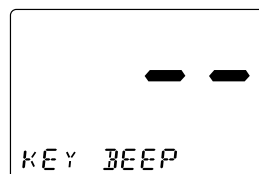

NMEA Technical Setup

VHF500 NMEA0183 GPS Input Connection Specification

This section is useful when attaching an external GPS to the **VHF500** radio. Many GPS units have a setup menu to be able to configure the NMEA0183 serial data output. This output can be used to supply information to other devices on the vessel, such as the **VHF500** DSC VHF radio, auto pilots, chart plotters, etc.

To setup the GPS to be used with the **VHF500** radio, the following items need to be considered for proper operation:

1. Baud Rate – Set the Baud rate to 4800.
2. Data Bits – Set the Data Bits to 8.
3. Parity – Set the Parity to None.
4. Stop Bits – Set the Stop Bits to 1.
5. GPRMC Command – This command is used by the **VHF500** and includes the UTC Time, Latitude, Longitude, Speed, Direction, and Date information.

The data amplitude : Over 3.0V

Drive capability : Over 10mA

Optional Accessories

- Flush mounting bracket for “in dash” installation.
(White = 500FMW, Black = 500FMB)

Contact your West Marine store or dealer from whom you purchased the radio for information.

VHF FM Marine Radio Telephone Channel and Functions (USA Channels)

CHANNEL DESIG	FREQUENCY (MHz) TRANSMIT	RECEIVE	TYPE OF TRAFFIC	SHIP TO HIP	SHIP TO SHORE	CH Name	FULL NAME
WX0	—	163.275	NOAA Weather	RX Only	RX Only		
WX1	—	162.550	NOAA Weather	RX Only	RX Only		
WX2	—	162.400	NOAA Weather	RX Only	RX Only		
WX3	—	162.475	NOAA Weather	RX Only	RX Only		
WX4	—	162.425	NOAA Weather	RX Only	RX Only		
WX5	—	162.450	NOAA Weather	RX Only	RX Only		
WX6	—	162.500	NOAA Weather	RX Only	RX Only		
WX7	—	162.525	NOAA Weather	RX Only	RX Only		
WX8	—	161.650	Can. Weather	RX Only	RX Only		
WX9	—	161.775	Can. Weather	RX Only	RX Only		
01	156.050	156.050	VTS	Yes	Yes	VTS/COMMERCL	VESSEL TRAFFIC SYSTEM/COMMERCIAL
02							
03	156.150	156.150	Port Ops	Yes	Yes	CG ONLY	COAST GUARD.GOV'T ONLY
04							
05	156.250	156.250	VTS	Yes	Yes	VTS/COMMERCL	VESSEL TRAFFIC SYSTEM/COMMERCIAL
06	156.300	156.300	Safety	Yes	No	SAFETY	INTER-SHIP SAFETY
07	156.350	156.350	Com'1	Yes	Yes	COMMERCIAL	COMMERCIAL
08	156.400	156.400	Com'1	Yes	No	COMMERCIAL	COMMERCIAL
09	156.450	156.450	Com'1 & Non Com'1	Yes	Yes	NON COMMERCL	NON COMMERCIAL
10	156.500	156.500	Com'1	Yes	Yes	COMMERCIAL	COMMERCIAL
11	156.550	156.550	Com'1	Yes	Yes	VSL TRAFFIC	VESSEL TRAFFIC SYSTEM
12	156.600	156.600	Port Ops	Yes	Yes	VSL TRAFFIC	VESSEL TRAFFIC SYSTEM
13	156.650	156.650	Navigational, TX 1W only	Yes	Yes	BRDG TO BRDG	BRIDGE TO BRIDGE
14	156.700	156.700	Port Ops	Yes	Yes	VSL TRAFFIC	VESSEL TRAFFIC SYSTEM
15	—	156.750	Environmental	RX Only	RX Only	ENVIRONMENTL	ENVIRONMENTAL
16	156.800	156.800	Safety Calling	Yes	Yes	DISTRESS	DISTRESS.SAFETY.CALLING
17	156.850	156.850	State Control	Yes	Yes	GOVERNMENT	GOV'T MARITIME CONTROL
18	156.900	156.900	Com'1	Yes	Yes	COMMERCIAL	COMMERCIAL
19	156.950	156.950	Com'1	Yes	Yes	COMMERCIAL	COMMERCIAL
20	157.000	157.000	Port Ops, RX Duplex	Yes	Yes	PORT OPERATN	PORT OPERATION
21	157.050	157.050	Coast Guard	Yes	Yes	COAST GUARD	COAST GUARD ONLY
22	157.100	157.100	Coast Guard	Yes	Yes	COAST GUARD	COAST GUARD
23	157.150	157.150	Coast Guard	Yes	Yes	COAST GUARD	COAST GUARD ONLY
24	157.200	161.800	Public Corresp.Duplex	No	Yes	MAR OPERATOR	MARINE OPERATOR
25	157.250	161.850	Public Corresp.Duplex	No	Yes	MAR OPERATOR	MARINE OPERATOR
26	157.300	161.900	Public Corresp.Duplex	No	Yes	MAR OPERATOR	MARINE OPERATOR
27	157.350	161.950	Public Corresp.Duplex	No	Yes	MAR OPERATOR	MARINE OPERATOR
28	157.400	162.000	Public Corresp.Duplex	No	Yes	MAR OPERATOR	MARINE OPERATOR
60							
61	156.075	156.075				COAST GUARD	COAST GUARD
62							
63	156.175	156.175				VSL TRAFFIC	VESSEL TRAFFIC SYSTEM
64	156.225	156.225				COMMERCIAL	COMMERCIAL
65	156.275	156.275	Port Ops	Yes	Yes	PORT OPERATN	PORT OPERATION
66	156.325	156.325	Port Ops	Yes	Yes	PORT OPERATN	PORT OPERATION
67	156.375	156.375	Com'1, TX 1W only	Yes	No	BRDG TO BRDG	BRIDGE TO BRIDGE
68	156.425	156.425	Non Com'1	Yes	Yes	NON COMMERCL	NON COMMERCIAL
69	156.475	156.475	Non Com'1	Yes	Yes	NON COMMERCL	NON COMMERCIAL
70	156.525	156.525				DSC REC ONLY	DIGITAL SELECTIVE CALLING
71	156.575	156.575	Non Com'1	Yes	Yes	NON COMMERCL	NON COMMERCIAL
72	156.625	156.625	Non Com'1	Yes	No	NON COMMERCL	NON COMMERCIAL (SHIP-SHIP)
73	156.675	156.675	Port Ops	Yes	Yes	PORT OPERATN	PORT OPERATION
74	156.725	156.725	Port Ops	Yes	Yes	PORT OPERATN	PORT OPERATION
75	156.775	156.775	Port Ops	Yes	Yes	PORT OPERATN	PORT OPERATION
76	156.825	156.825	Port Ops	Yes	Yes	PORT OPERATN	PORT OPERATION
77	156.875	156.875	Port Ops	Yes	No	PORT OPERATN	PORT OPERATION (SHIP-SHIP)
78	156.925	156.925	Non Com'1	Yes	Yes	NON COMMERCL	NON COMMERCIAL
79	156.975	156.975	Com'1	Yes	Yes	COMMERCIAL	COMMERCIAL
80	157.025	157.025	Com'1	Yes	Yes	COMMERCIAL	COMMERCIAL
81	157.075	157.075	Coast Guard	Yes	Yes	COAST GUARD	COAST GUARD
82	157.125	157.125	US Gov't Only	Yes	Yes	COAST GUARD	COAST GUARD
83	157.175	157.175	Coast Guard	Yes	Yes	GOVERNMENT	GOVERNMENT
84	157.225	161.825	Public Corresp.Duplex	No	Yes	MAR OPERATOR	MARINE OPERATOR
85	157.275	161.875	Public Corresp.Duplex	No	Yes	MAR OPERATOR	MARINE OPERATOR
86	157.325	161.925	Public Corresp.Duplex	No	Yes	MAR OPERATOR	MARINE OPERATOR
87	157.375	161.975	Public Corresp.Duplex	No	Yes	MAR OPERATOR	MARINE OPERATOR
88	157.425	157.425	Com'1	Yes	No	COMMERCIAL	COMMERCIAL (SHIP-SHIP)

VHF FM Marine Radio Telephone Channel and Functions (International Channels)

CHANNEL DESIG	FREQUENCY (MHz) TRANSMIT	RECEIVE	TYPE OF TRAFFIC	SHIP TO HIP	SHIP TO SHORE	CH Name	FULL NAME
WX0	—	163.275	NOAA Weather	RX Only	RX Only		
WX1	—	162.550	NOAA Weather	RX Only	RX Only		
WX2	—	162.400	NOAA Weather	RX Only	RX Only		
WX3	—	162.475	NOAA Weather	RX Only	RX Only		
WX4	—	162.425	NOAA Weather	RX Only	RX Only		
WX5	—	162.450	NOAA Weather	RX Only	RX Only		
WX6	—	162.500	NOAA Weather	RX Only	RX Only		
WX7	—	162.525	NOAA Weather	RX Only	RX Only		
WX8	—	161.650	Can. Weather	RX Only	RX Only		
WX9	—	161.775	Can. Weather	RX Only	RX Only		
01	156.050	160.650	VTS,Duplex	Yes	Yes	MAR OPERATOR	MARINE OPERATOR
02	156.100	160.700	Port Ops,Duplex	Yes	Yes	MAR OPERATOR	MARINE OPERATOR
03	156.150	160.750	Port Ops,Duplex	Yes	Yes	MAR OPERATOR	MARINE OPERATOR
04	156.200	160.800	Port Ops,Duplex	Yes	Yes	MAR OPERATOR	MARINE OPERATOR
05	156.250	160.850	VTS,Duplex	Yes	Yes	MAR OPERATOR	MARINE OPERATOR
06	156.300	156.300	Safety	Yes	No	SAFETY	INTER-SHIP SAFETY
07	156.350	160.950	Com',Duplex	Yes	Yes	MAR OPERATOR	MARINE OPERATOR
08	156.400	156.400	Com'1	Yes	No	COMMERCIAL	COMMERCIAL (SHIP-SHIP)
09	156.450	156.450	Com'1 & Non Com'1	Yes	Yes	CALLING	BOATER CALLING CHANNEL
10	156.500	156.500	Com'1	Yes	Yes	COMMERCIAL	COMMERCIAL
11	156.550	156.550	Com'1	Yes	Yes	VSL TRAFFIC	VESSEL TRAFFIC SYSTEM
12	156.600	156.600	Port Ops	Yes	Yes	VSL TRAFFIC	VESSEL TRAFFIC SYSTEM
13	156.650	156.650	Navigational	Yes	Yes	BRDG TO BRDG	BRIDGE TO BRIDGE
14	156.700	156.700	Port Ops	Yes	Yes	VSL TRAFFIC	VESSEL TRAFFIC SYSTEM
15	156.750	156.750	Environmental	Yes	Yes	ENVIRONMENTL	ENVIRONMENTAL
16	156.800	156.800	Safety Calling	Yes	Yes	DISTRESS	DISTRESS,SAFETY,CALLING
17	156.850	156.850	State Control	Yes	Yes	GOVERNMENT	GOVT MARITIME CONTROL
18	156.900	161.500	Com'1,Duplex	Yes	Yes	PORT OPERATN	PORT OPERATION
19	156.950	161.550	Com'1,Duplex	Yes	Yes	COMMERCIAL	COMMERCIAL
20	157.000	161.600	Port Ops,Duplex	Yes	Yes	PORT OPERATN	PORT OPERATION
21	157.050	161.650	Coast Guard,Duplex	Yes	Yes	PORT OPERATN	PORT OPERATION
22	157.100	161.700	Coast Guard,Duplex	Yes	Yes	PORT OPERATN	PORT OPERATION
23	157.150	161.750	Coast Guard,Duplex	Yes	Yes	MAR OPERATOR	MARINE OPERATOR
24	157.200	161.800	Public Corresp,Duplex	No	Yes	MAR OPERATOR	MARINE OPERATOR
25	157.250	161.850	Public Corresp,Duplex	No	Yes	MAR OPERATOR	MARINE OPERATOR
26	157.300	161.900	Public Corresp,Duplex	No	Yes	MAR OPERATOR	MARINE OPERATOR
27	157.350	161.950	Public Corresp,Duplex	No	Yes	MAR OPERATOR	MARINE OPERATOR
28	157.400	162.000	Public Corresp,Duplex	No	Yes	MAR OPERATOR	MARINE OPERATOR
60	156.025	160.625	Duplex			MAR OPERATOR	MARINE OPERATOR
61	156.075	160.675	Duplex			MAR OPERATOR	MARINE OPERATOR
62	156.125	160.725	Duplex			MAR OPERATOR	MARINE OPERATOR
63	156.175	160.775	Duplex			MAR OPERATOR	MARINE OPERATOR
64	156.225	160.825	Duplex			MAR OPERATOR	MARINE OPERATOR
65	156.275	160.875	Port Ops,Duplex	Yes		MAR OPERATOR	MARINE OPERATOR
66	156.325	160.925	Port Ops,Duplex	Yes	Yes	MAR OPERATOR	MARINE OPERATOR
67	156.375	156.375	Com'1	Yes	No	BRDG TO BRDG	BRIDGE TO BRIDGE
68	156.425	156.425	Non Com'1	Yes	Yes	NON COMMERCL	NON COMMERCIAL
69	156.475	156.475	Non Com'1	Yes	Yes	NON COMMERCL	NON COMMERCIAL
70	156.525	156.525				DSC REC ONLY	DIGITAL SELECTIVE CALLING
71	156.575	156.575	Non Com'1	Yes	Yes	NON COMMERCL	NON COMMERCIAL
72	156.625	156.625	Non Com'1	Yes	No	NON COMMERCL	NON COMMERCIAL
73	156.675	156.675	Port Ops	Yes	Yes	PORT OPERATN	PORT OPERATION
74	156.725	156.725	Port Ops	Yes	Yes	PORT OPERATN	PORT OPERATION
75	156.775	156.775	Port Ops	Yes	Yes	PORT OPERATN	PORT OPERATION
76	156.825	156.825	Port Ops	Yes	Yes	PORT OPERATN	PORT OPERATION
77	156.875	156.875	Port Ops	Yes	No	PORT OPERATN	PORT OPERATION (SHIP-SHIP)
78	156.925	161.525	Non Com'1,Duplex	Yes	Yes	PORT OPERATN	PORT OPERATION
79	156.975	161.575	Com'1,Duplex	Yes	Yes	PORT OPERATN	PORT OPERATION
80	157.025	161.625	Com'1,Duplex	Yes	Yes	PORT OPERATN	PORT OPERATION
81	157.075	161.675	Coast Guard,Duplex	Yes	Yes	PORT OPERATN	PORT OPERATION
82	157.125	161.725	US Govt Only,Duplex	Yes	Yes	PORT OPERATN	PORT OPERATION
83	157.175	161.775	Coast Guard,Duplex	Yes	Yes	PORT OPERATN	PORT OPERATION
84	157.225	161.825	Public Corresp,Duplex	No	Yes	MAR OPERATOR	MARINE OPERATOR
85	157.275	161.875	Public Corresp,Duplex	No	Yes	MAR OPERATOR	MARINE OPERATOR
86	157.325	161.925	Public Corresp,Duplex	No	Yes	MAR OPERATOR	MARINE OPERATOR
87	157.375	161.975	Public Corresp,Duplex	No	Yes	MAR OPERATOR	MARINE OPERATOR
88	157.425	162.025	Com'1,Duplex	Yes	No	MAR OPERATOR	MARINE OPERATOR

VHF FM Marine Radio Telephone Channel and Functions (Canadian Channels)

CHANNEL DESIG	FREQUENCY (MHz) TRANSMIT	RECEIVE	TYPE OF TRAFFIC	SHIP TO HIP	SHIP TO SHORE	CH Name	FULL NAME
WX0	—	163.275	NOAA Weather	RX Only	RX Only		
WX1	—	162.550	NOAA Weather	RX Only	RX Only		
WX2	—	162.400	NOAA Weather	RX Only	RX Only		
WX3	—	162.475	NOAA Weather	RX Only	RX Only		
WX4	—	162.425	NOAA Weather	RX Only	RX Only		
WX5	—	162.450	NOAA Weather	RX Only	RX Only		
WX6	—	162.500	NOAA Weather	RX Only	RX Only		
WX7	—	162.525	NOAA Weather	RX Only	RX Only		
WX8	—	161.650	Can. Weather	RX Only	RX Only		
WX9	—	161.775	Can. Weather	RX Only	RX Only		
01	156.050	160.650	Duplex	Yes	Yes	MAR OPERATOR	MARINE OPERATOR
02	156.100	160.700	Duplex	Yes	Yes	MAR OPERATOR	MARINE OPERATOR
03	156.150	160.750	Duplex	Yes	Yes	MAR OPERATOR	MARINE OPERATOR
04	156.200	156.200		Yes	Yes	COAST GUARD	COAST GUARD
05	156.250	156.250		Yes	Yes	VSL TRAFFIC	VESSEL TRAFFIC SYSTEM
06	156.300	156.300		Yes	No	SAFETY	INTER-SHIP SAFETY
07	156.350	156.350		Yes	Yes	COMMERCIAL	COMMERCIAL
08	156.400	156.400		Yes	No	COMMERCIAL	COMMERCIAL
09	156.450	156.450		Yes	Yes	CALLING	BOATER CALLING CHANNEL
10	156.500	156.500		Yes	Yes	COMMERCIAL	COMMERCIAL
11	156.550	156.550		Yes	Yes	VSL TRAFFIC	VESSEL TRAFFIC SYSTEM
12	156.600	156.600		Yes	Yes	VSL TRAFFIC	VESSEL TRAFFIC SYSTEM
13	156.650	156.650	1W	Yes	Yes	BRDG TO BRDG	BRIDGE TO BRIDGE
14	156.700	156.700		Yes	Yes	VSL TRAFFIC	VESSEL TRAFFIC SYSTEM
15	156.750	156.750	1W	Yes	Yes	ENVIRONMENTL	ENVIRONMENTAL
16	156.800	156.800		Yes	Yes	DISTRESS	DISTRESS,SAFETY,CALLING
17	156.850	156.850	1W	Yes	Yes	STATE CNTRL	STATE CONTROL
18	156.900	156.900		Yes	Yes	COMMERCIAL	COMMERCIAL
19	156.950	156.950		Yes	Yes	COAST GUARD	CANADIAN COAST GUARD
20	157.000	161.600	Duplex, 1W	Yes	Yes	PORT OPERATN	PORT OPERATION
21	157.050	157.050		Yes	Yes	COAST GUARD	COAST GUARD
22	157.100	157.100		Yes	Yes	COAST GUARD	COAST GUARD
23	157.150	161.750	Duplex	Yes	Yes	COAST GUARD	COAST GUARD
24	157.200	161.800	Duplex	No	Yes	MAR OPERATOR	MARINE OPERATOR
25	157.250	161.850	Duplex	No	Yes	MAR OPERATOR	MARINE OPERATOR
26	157.300	161.900	Duplex	No	Yes	MAR OPERATOR	MARINE OPERATOR
27	157.350	161.950	Duplex	No	Yes	MAR OPERATOR	MARINE OPERATOR
28	157.400	162.000	Duplex	No	Yes	MAR OPERATOR	MARINE OPERATOR
60	156.025	160.625	Duplex			MAR OPERATOR	MARINE OPERATOR
61	156.075	156.075				COAST GUARD	COAST GUARD
62	156.125	156.125				COAST GUARD	COAST GUARD
63	—	—					
64	156.225	156.225	Simplex			MAR OPERATOR	MARINE OPERATOR
65	156.275	156.275		Yes	Yes	SRCH RESCUE	SEARCH AND RESCUE
66	156.325	156.325		Yes	Yes	PORT OPERATN	PORT OPERATION
67	156.375	156.375		Yes	No	BRDG TO BRDG	BRIDGE TO BRIDGE
68	156.425	156.425		Yes	Yes	NON COMMERCL	NON COMMERCIAL
69	156.475	156.475		Yes	Yes	NON COMMERCL	NON COMMERCIAL
70	156.525	156.525				DSC REC ONLY	DIGITAL SELECTIVE CALLING
71	156.575	156.575		Yes	Yes	NON COMMERCL	NON COMMERCIAL
72	156.625	156.625		Yes	No	NON COMMERCL	NON COMMERCIAL
73	156.675	156.675		Yes	Ye	PORT OPERATN	PORT OPERATION
74	156.725	156.725		Yes	Ye	PORT OPERATN	PORT OPERATION
75	156.775	156.775	Port Ops	Yes	Yes	PORT OPERATN	PORT OPERATION
76	156.825	156.825	Port Ops	Yes	Yes	PORT OPERATN	PORT OPERATION
77	156.875	156.875		Yes	No	PORT OPERATN	PORT OPERATION
78	156.925	156.925		Yes	Yes	INTER SHIP	INTER SHIP
79	156.975	156.975		Yes	Yes	INTER SHIP	INTER SHIP
80	157.025	157.025		Yes	Yes	INTER SHIP	INTER SHIP
81	157.075	157.075		Yes	Yes	COAST GUARD	COAST GUARD
82	157.125	157.125		Yes	Yes	COAST GUARD	COAST GUARD
83	157.175	157.175		Yes	Yes	COAST GUARD	COAST GUARD
84	157.225	161.825	Duplex	No	Yes	MAR OPERATOR	MARINE OPERATOR
85	157.275	161.875	Duplex	No	Yes	MAR OPERATOR	MARINE OPERATOR
86	157.325	161.925	Duplex	No	Yes	MAR OPERATOR	MARINE OPERATOR
87	157.375	161.975	Duplex	No	Yes	MAR OPERATOR	MARINE OPERATOR
88	157.425	162.025	Duplex	Yes	No	MAR OPERATOR	MARINE OPERATOR

NWR-SAME EVENT CODE

Event Code	Standard	EVENT LEVEL (Siren Type)				Radio Status Display
		Warning	Watch	Statement	Test	
Emergency Action Notification	EAN	0				EMG NOTIFY
Emergency Action Termination	EAT	0				EMG END
National Information Center	NIC	0				NATION INFO
Tornado Warning #	TOW (or TOR)	0				TORNADO
Severe Thunderstorm Warning #	SVW (or SVR)	0				THUNDERSTORM
Flash Flood Warning	FFW	0				FLASH FLOOD
Flood Warning	FLW	0				FLOOD
Winter Storm Warning	WSW	0				WINTER STORM
Blizzard Warning	BZW	0				BLIZZARD
High Wind/Dust Storm Warning	HWW	0				HIGH WIND
Radiological Hazard Warning	RHW	0				RADIOLOGICAL
Civil Danger Warning	CDW	0				CIVILDANGER
Local Area Emergency	LAE	0				LOCAL EMG
Hazardous Material Warning	HMW	0				HAZARDOUS
Civil Emergency Message	CEM	0				CIVIL EMG
Immediate Evacuation Warning	IEW	0				EVACUATION
Immediate Evacuation Notice	EVI	0				EVACUATENOTE
Law Enforcement Warning	LEW	0				LAW ENFORCE
Fire Warning	FRW	0				FIRE
Hurricane/Tropical Storm Warning	HUW	0				HURRICANE
Tsunami Warning	TSW	0				TSUNAMI
Coastal Flood Warning	CFW	0				COAST FLOOD
Special Marine Warning	SMW	0				SPECIAL MRN
Avalanche Warning	AVW	0				AVALANCHE
Volcano Warning	VOW	0				VOLCANO
Shelter In Place Warning	SPW	0				SHELTER
Child Abduction Emergency	CAE	0				CHILD EMG
Dust Storm Warning	DSW	0				DUST STORM
Earthquake Warning	EQW	0				EARTHQUAKE
911 Telephone Outage Emergency	TOE	0				911 OUTAGE
Nuclear Power Plant Warning	NUW	0				NUCLEAR
Tropical Storm Warning	TRW	0				TROPIC STORM
Nuclear Power Plant Warning	NPW	0				NUCLEAR
Nuclear Power Plant Warning	NPP	0				NUCLEAR
Dam Break Warning	DBW	0				DAM BREAK
Civil Danger Watch	CDA		0			CIVIL DANGER
Radiological Hazard Watch	RHA		0			RADIOLOGICAL
Hazardous Material Watch	HMA		0			HAZARDOUS
Winter Storm Watch	WSA		0			WINTER STORM
High Wind/Dust Storm Watch	HWA		0			HIGH WIND
Tornado Watch	TOA		0			TORNADO
Severe Thunderstorm Watch	SWA		0			THUNDERSTORM
Flash Flood Watch	FFA		0			FLASH FLOOD
Flood Watch	FLA		0			FLOOD
Hurricane/Tropical Storm Watch	HUA		0			HURRICANE
Tsunami Watch	TSA		0			TSUNAMI
Coastal Flood Watch	CFA		0			COAST FLOOD
Avalanche Watch	AVA		0			AVALANCHE
Volcano Watch	VOA		0			VOLCANO
Tropical Storm Watch	TRA		0			TROPIC STORM
Dust Storm Watch	DSA		0			DUST STORM
Earthquake Watch	EQA		0			EARTHQUAKE
Severe Weather Statement	SVS			0		SEVERE WX
Special Weather Statement	SPS			0		SPECIAL WX
Flash Flood Statement	FFS			0		FLASH FLOOD
Flood Statement	FLS			0		FLOOD
Hurricane Statement	HLS			0		HURRICANE
Administrative Message	ADR			0		ADMIN MSG
Network Message Notification	NMN			0		NETWORK MSG
Missing Child Statement	MIS			0		MISS CHILD
School Closing Statement	SCS			0		SCHOOL CLOSE
National Periodic Test	NPT				0	NATIONPERIOD
Required Monthly Test	RMT				0	MONTHLY
Required Weekly Test	RWT				0	WEEKLY
Nuclear Power Plant Test Message	NPM				0	NUCLEAR
System Demonstration/Practice	DMO					SYSTEM DEMO
NATIONAL HAZARD WARNING	NHW	0				NATIONHAZARD
UNKNOWN EMERGENCY TUNE TV	**E	0				UNKNOWN TV
UNKNOWN WARNING TUNE TV	**W	0				UNKNOWN TV
UNKNOWN WATCH TUNE TV	**A		0			UNKNOWN TV
UNKNOWN STATEMENT TUNE TV	**S			0		UNKNOWN TV

Specification

General

Channels	: Transmit 54 Receive 77 Marine/10 Weather
Controls	: On-Off/Volume, Squelch
Status Indicators	: TX (Transmit), TRI (Triple Watch), HI (High), LO (Low), U, C, I, MEM, WX, DSC, ☉ (Alarm), 🚨 (Alert), 📶 (GPS), 📻 (WHAM), and Channel Display
Channel Display Buttons	: Radio Status Display with Orange backlight : 16/9/TRI, DISTRESS, PA, MEM/UIC, SELECT, STEP/SCAN, H/L/MENU, WX/ALERT, CHANNEL ▲, CHANNEL ▼
Connectors	: Antenna, Remote, ACC, and DC power
Size	: H63 mm x W160 mm x L183 mm (W/O Heat Sink) H2.52 inches x W6.4 inches x L6.72 inches
Weight	: 1.1 kg / 2.42 lbs / 38.9 oz
Supply Voltage	: 13.8V DC negative ground
Standard Accessories	: Mounting bracket and hardware, DC power cord, microphone hanger, spare fuse, ACC Cable
Antenna Impedance	: 50 Ω nominal
Microphone	: Rugged 2 kΩ condenser mic element with coiled cord
Speaker	: 1.82 inch, Mylar Cone 8 Ω
Operating Temperature Range	: -20 °C to + 50 °C (-4 °F to +122 °F)
Shock and Vibration	: Meets or exceeds EIA standards, RS152B and RS204C
FCC Approvals	: Type accepted under part 80 of the Rules; meets Great Lakes Agreement and party boat requirements

Transmitter

Power Output	: 1 watt or 25 watt (switch selectable)
Power Requirement	: Not rated on LO, 25 watts output: 4.9A @ 13.8V DC
Modulation	: FM ±5 kHz deviation (FCC designator F3E)
Hum and Noise Signal-to-Noise	: 45 dB @ 1 kHz with 3 kHz deviation with 1000 Hz modulating frequency (nominal)
Audio Distortion	: Less than 8% with 3 kHz deviation with 1000 Hz modulating frequency
Spurious Suppression	: -45 dBm @ Hi, -45 dBm @ Lo
Output Power Stabilization	: Built-in automatic level control (ALC)
Frequency Range	: 156 to 158 MHz
Frequency Stability	: ±5 ppm @ -20°C to + 50°C

Receiver

Frequency Range	: 156 to 163 MHz
Sensitivity	: 0.23 μV for 12 dB SINAD
Circuit	: Dual Conversion Super Heterodyne PLL
Squelch Sensitivity	: 0.15 μV Threshold
Spurious Response	: 65 dB
Adjacent Channel Selectivity	: 67 dB @ ±25 kHz
Audio Output Power	: 2.8 watts (10% Distortion)
Power Requirement	: 350 mA @ 13.8V DC squelched, 900mA @ 13.8V DC at maximum audio output
IF Frequencies	: 1st 21.4 MHz, 2nd -455 kHz

Troubleshooting

In the event that the radio fails to perform, or needs servicing, please send directory to our Electronics Repair Center in Hollister, CA. Be sure to include your return mailing information and detailed accounting of the problems experienced and/or the service requested.

West Marine
 Electronics Repair Center
 2395 Bert Court
 Hollister, CA 95023
 Please call us at 831-761-4205

SYMPTOM	CAUSE	REMEDY
Won't power On.	No or low voltage.	Check for blown fuse. Check power connections, circuit breaker on branch circuit.
When the PTT is pressed - Tx icon comes on and another radio can hear a "click" but no audio is heard.	Bad mic element.	Send in for repair.
While scanning, the radio stops on a particular channel all of the time.	A source of noise is nearby.	Turn Squelch clockwise to reduce noise so that scan function skips channel.
There is noise on the receiver that the squelch will not eliminate.	An external noise is being generated by some device.	Either turn off the offending device or contact that Mfg. Regarding FCC part 15 "unintentional radiator".
You have arranged to communicate with another VHF radio user on a specific channel, and you can not hear them.	You and the other user are using different Country Codes.	Make sure that you are both using the same Country mode (USA, International, or Canadian). Several channels have the same numeric designation, but are either on different frequencies or the channels are used for different purpose. Channel 16, the Distress, Safety, and Calling channel, is the same on all three bands.

SYMPTOM	CAUSE	REMEDY
You can not change the transmit power setting.	You are on a channel which is limited to 1 watt transmit power (e.g. Ch. 13) or you are on a "receive only" channel (e.g. WX).	Change to an unrestricted TX/RX channel.
The SCAN key does not start the scan function.	CAUSE 1: No cahnnels are in the scan memory. CAUSE 2: Squelch is not adjusted correctly.	REMEDY 1: Use the MEM/UIC key to enter desired channels into the scan memory. REMEDY 2: Adjust the squelch to the point that background noise just disappears.
You can hear transmissions, but the other radio cannot hear you.	The transmit power is set to low.	Use the H/L/MENU key to select a higher transmit power setting.

Care and Maintenance

Your **VHF500** is a precision of electronic equipment and you should treat it accordingly. Due to the rugged design, very little maintenance is required. However, a few precautions should be observed:

- If the antenna has been damaged, you should not transmit except in the case of an emergency. A defective antenna may cause damage to your radio.
- You are responsible for continued FCC technical compliance of your radio.

West Marine
Electronics Repair Center
2395 Bert Court
Hollister, CA 95023
Please call us at 831-761-4205

Three Year Limited Warranty

WARRANTOR: WEST MARINE AMERICA CORPORATION (“West Marine”)

ELEMENTS OF WARRANTY: West Marine warrants, for three years, to the original retail owner, this West Marine Product to be free from defects in materials and craftsmanship with only the limitations or exclusions set out below.

WARRANTY DURATION: This warranty to the original user shall terminate and be of no further effect 36 months after the date of original retail sale. The warranty is invalid if the Product is (A) damaged or not maintained as reasonable or necessary, (B) modified, altered, or used as part of any conversion kits, subassemblies, or any configurations not sold by West Marine, (C) improperly installed, (D) serviced or repaired by someone other than an authorized West Marine service center for a defect or malfunction covered by this warranty, (E) used in any conjunction with equipment or parts or as part of any system not manufactured by West Marine, or (F) installed or programmed by anyone other than as detailed by the Operating Guide for this product.

STATEMENT OF REMEDY: In the event that the product does not conform to this warranty at any time while this warranty is in effect, warrantor will repair the defect and return it to you without charge for parts, service, or any other cost (except shipping and handling) incurred by warrantor or its representatives in connection with the performance of this warranty. THE LIMITED WARRANTY SET FORTH ABOVE IS THE SOLE AND ENTIRE WARRANTY PERTAINING TO THE PRODUCT AND IS IN LIEU OF AND EXCLUDES ALL OTHER WARRANTIES OF ANY NATURE WHATSOEVER, WHETHER EXPRESS, IMPLIED OR ARISING BY OPERATION OF LAW, INCLUDING, BUT NOT LIMITED TO ANY IMPLIED WARRANTIES OF MERCHANTABILITY OR FITNESS FOR A PARTICULAR PURPOSE. THIS WARRANTY DOES NOT COVER OR PROVIDE FOR THE REIMBURSEMENT OR PAYMENT OF INCIDENTAL OR CONSEQUENTIAL DAMAGES. Some states do not allow this exclusion or limitation of incidental or consequential damages so the above limitation or exclusion may not apply to you.

LEGAL REMEDIES: This warranty gives you specific legal rights, and you may also have other rights which vary from state to state. This warranty is void outside the United States of America.

PROCEDURE FOR OBTAINING PERFORMANCE OF WARRANTY: If, after following the instructions in this Operating Guide you are certain that the Product is defective, pack the Product carefully (preferably in its original packaging). Include evidence of original purchase and a note describing the defect that has caused you to return it. The Product should be shipped freight prepaid, by traceable means, or delivered, to warrantor at:

QUESTIONS?

*Contact your local
West Marine store*

Call 1-800-BOATING

*Contact us at
www.westmarine.com*

 **West Marine**[®]
Watsonville, CA

Made in China
Fabriqué en China
Hecho en China

UTZZ01920ZA(0)